



ELECTRONIC CONTROL TERMINOLOGY & COMPONENT DESCRIPTIONS

All 700-3 Series units utilize an electronic control system which monitors, regulates, controls and displays a variety of functions and operations in the appliance.

The table below defines some of the basic electronic control system terminology.

Term/Component	Definition / Description
Main Control Board	The printed-circuit board (PC Board) which contains a microprocessor, relays, triacs and electrical connections that monitor and control all functions of the appliance.
Microprocessor	An electrical component on the control board which receives electrical signals from other components, processes the information, then sends electrical signals to relays and triacs on the board to open or close, switching components in the appliance ON or OFF.
Relay	An electrical component on the control board which switches other components in the appliance ON or OFF when instructed to do so by the microprocessor.
Triac	Similar in function to the relay, the triac is a three terminal semiconductor for controlling current in either direction.
Control Panel Assembly	(Also referred to as the Control Keypad Interface), is that part of the electronic control system where all input operations are performed.
Membrane Switch	Part of the control panel assembly, which consists of the function keys.
Keys (Function Keys)	The "buttons" on the Membrane Switch used for input operations: "POWER", "ALARM", "ICE MAKER", "WARMER" and "COLDER"
LCD (Liquid Crystal Display)	A semi-liquid substance sandwiched between glass in the display of the control panel assembly. The molecules of this semi-liquid substance have no specific orientation. However, when electricity is applied to them, they react predictably, aligning and straightening in such a way as to control light passage.
Indicators	The words, numbers and icons that appear on the display of the control panel assembly through the use of LCD's.
Error Codes	The code numbers that may appear on the display of the control panel assembly when accessing Error Code History. Error Codes are logged if the unit experienced specific problems related to electrical signals supplied by electrical components.
Temperature Units of Measure.....	Temperature observed on the display of the control panel assembly may be in Fahrenheit units of measure (°F) or Celsius units of measure (°C). A series of key strokes allows the temperature units of measure to be switched to display as either °F or °C.
Set-Point	The desired zone temperature, established by pressing the COLDER or WARMER keys.
High Offset (Cut-in)	As the zone air temperature cycles up and down, the high offset is the maximum zone temperature that the electronic control system will allow before calling for cooling.
Low Offset (Cut-out).....	As the zone air temperature cycles up and down, the low offset is the minimum zone air temperature that the electronic control system will allow before interrupting cooling.
Thermistor	(Also Referred to as a Temperature Sensor), is a resistor with which resistance changes as the temperature around it changes. For electronic control system purposes, the microprocessor measures the resistance, then displays it as a temperature reading.
Variable Speed Compressor	A compressor that runs at varying speeds depending on the temperature detected in the corresponding zone(s) of the appliance.

ELECTRONIC CONTROL SYSTEM OVERVIEW

This page contains the wiring schematic of the model 700BCI-3. Input operations for the electronic control system are performed at the control panel (located inside the upper drawer), with monitoring, regulating and controlling functions taking place at the main control board. Temperatures and possible problems with the unit are shown in the control panel display. The entire electronic control system is described in greater detail on the following pages.

NOTE: For more detailed electrical diagrams refer to the wiring diagram and schematic supplied with the unit.

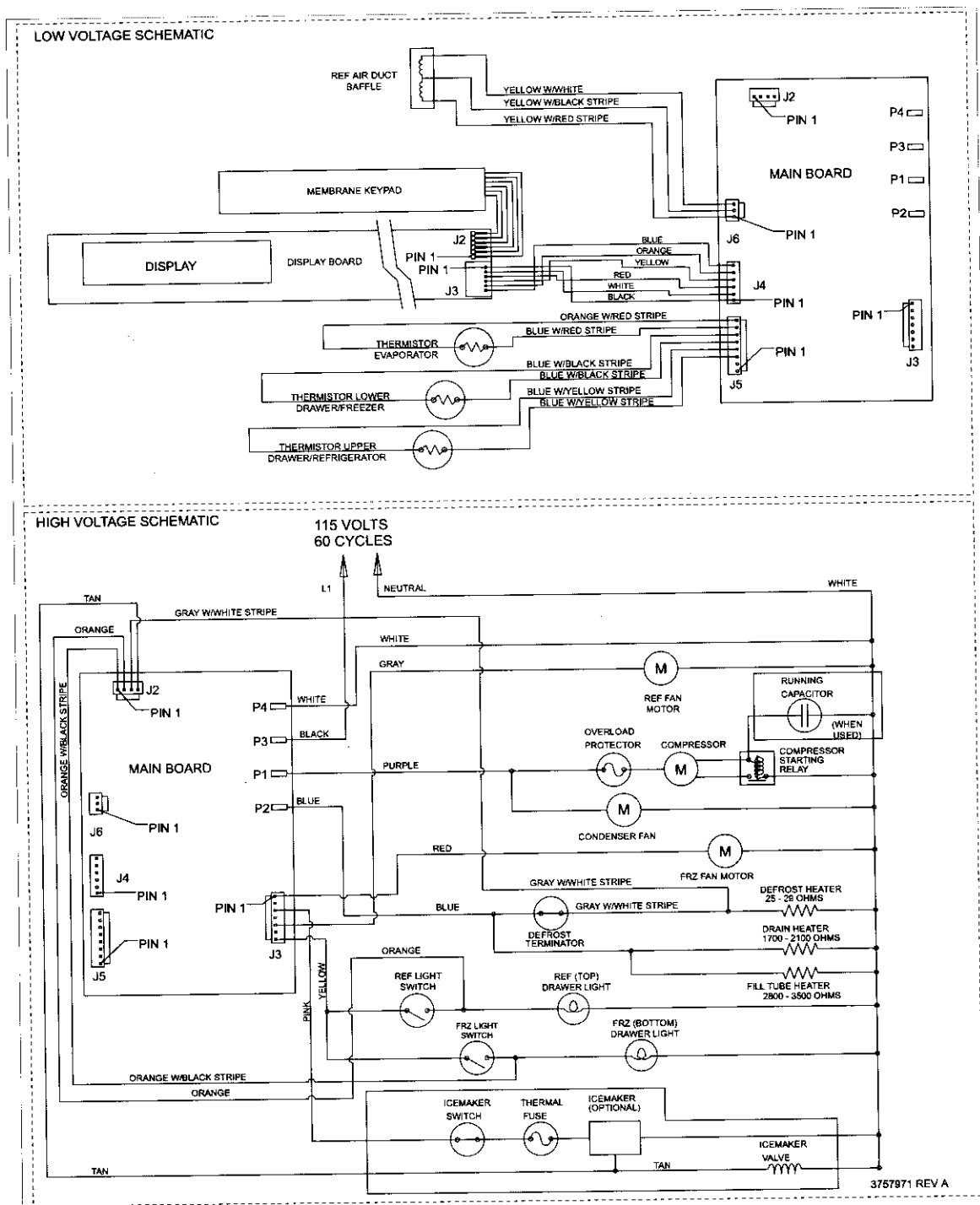

Figure 3-1. 700BCI-3 Wiring Schematic



MAIN CONTROL BOARD LAYOUT AND SUMMARY TABLE

Electrical connection points on the main control board are labeled alphanumerically. These labels correspond with the alphanumeric summary table, located on the wiring diagram. By referencing the summary table, it is possible to identify which components are connected at which points on the main control board. Below is a layout diagram of the main control board, and a copy of a model 700BCI-3 summary table. (See Figures 3-2 & 3-3)

NOTE: All components on the control board are non-replaceable. If a problem with the control board is identified, the complete control board must be replaced.

NOTE: There is also a small control board in the control panel assembly (Not Shown). All components in the control panel assembly are non-replaceable. If a problem with the control panel is identified, the complete control panel assembly must be replaced.

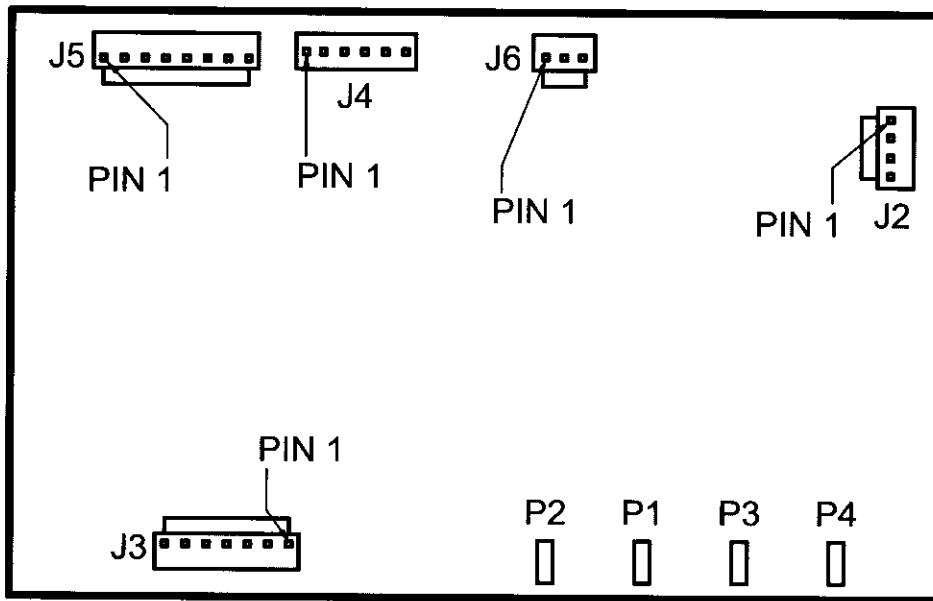

Figure 3-2. Main Control Board Layout

MAIN CONTROL BOARD SUMMARY				
TERMINAL	CIRCUIT	DESCRIPTION	FUNCTION	COLOR
120 VOLT CIRCUITS				
P4	LN	NEUTRAL	NEUTRAL INTO BOARD	WHITE
P3	L1	POWER IN	POWER INTO BOARD	BLACK
P1	COMPRESSOR	COMPRESSOR	POWERS COMPRESSOR AND CONDENSER FAN	PURPLE
P2	DEFROST	DEFROST HEATER	POWERS DEFROST CIRCUIT AND FILL TUBE HEATER	BLUE
J3-1	FAN 1	EVAPORATOR FAN	POWERS EVAPORATOR FAN	RED
J3-2		NOT USED		
J3-3	ICE	ICE MAKER	POWERS ICE MAKER	PINK
J3-4		NOT USED		
J3-5	FAN 2	REFRIGERATOR FAN	POWERS FFAN IN REFRIGERATOR	GRAY
J3-6		NOT USED		
J3-7	LIGHTS	LIGHTS	POWERS LIGHTS	YELLOW
J2-1	LWR	FRZ DRAWER LIGHT SENSE	SENSES IF FREEZER DRAWER OPEN	ORANGE/BLACK
J2-2	UPR	REF DRAWER LIGHT SENSE	SENSES IF REFRIGERATOR DRAWER OPEN	ORANGE
J2-3	DEF	DEFROST SENSOR	SENSES WHEN DEF HEATER SHUTS OFF	GRAY/WHITE
J2-4	ICE	ICE MAKER VALVE SENSOR	SENSES WATER VALVE ACTIVATION	TAN
LOW VOLTAGE THERMISTOR CIRCUITS				
J5-1,2		NOT USED		
J5-3,4	UPPER	REFRIGERATOR COMPARTMENT	SENSES REFRIGERATOR CABINET TEMPERATURE	BLUE/YELLOW
J5-5,6	LOWER	FREEZER COMPARTMENT	SENSES FREEZER CABINET TEMPERATURE	BLUE/BLACK
J5-7	EVAP	EVAPORATOR	SENSES EVAPORATOR TEMPERATURE	BLUE/RED
J5-8	EVAP	EVAPORATOR	SENSES EVAPORATOR TEMPERATURE	ORANGE/RED
J6-1	N	BAFFLE NEUTRAL	BAFFLE NEUTRAL	YELLOW/RED
J6-2	C	BAFFLE CLOSE	PULSED TO CLOSE BAFFLE	YELLOW/BLACK
J6-3	O	BAFFLE OPEN	PULSED TO OPEN BAFFLE	YELLOW/WHITE
J4-1	DISPLAY	DISPLAY WIRING	12VDC POWER SUPPLY FOR DISPLAY BOARD	BLACK
J4-2	DISPLAY	DISPLAY WIRING	12VDC POWER SUPPLY FOR DISPLAY BOARD	WHITE
J4-3	DISPLAY	DISPLAY WIRING	SERIAL DATA RECEIVE	RED
J4-4	DISPLAY	DISPLAY WIRING	SERIAL DATE TRANSMIT	YELLOW
J4-5	DISPLAY	DISPLAY WIRING	GROUND FOR DISPLAY BOARD POWER SUPPLY	ORANGE
J4-6	DISPLAY	DISPLAY WIRING	GROUND FOR DISPLAY BOARD POWER SUPPLY	BLUE

Figure 3-3. Main Control Board Summary Table

CONTROL PANEL LAYOUT

NOTE: The LCD on the base units is not back lit. It will appear darker than the LCD on tall units.

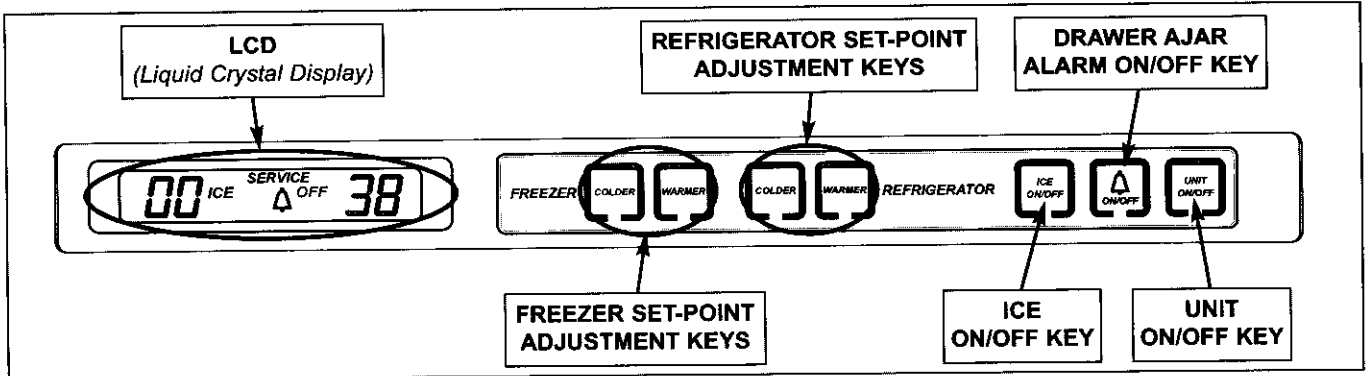

Figure 3-4. 700BCI-3 Control Panel Layout

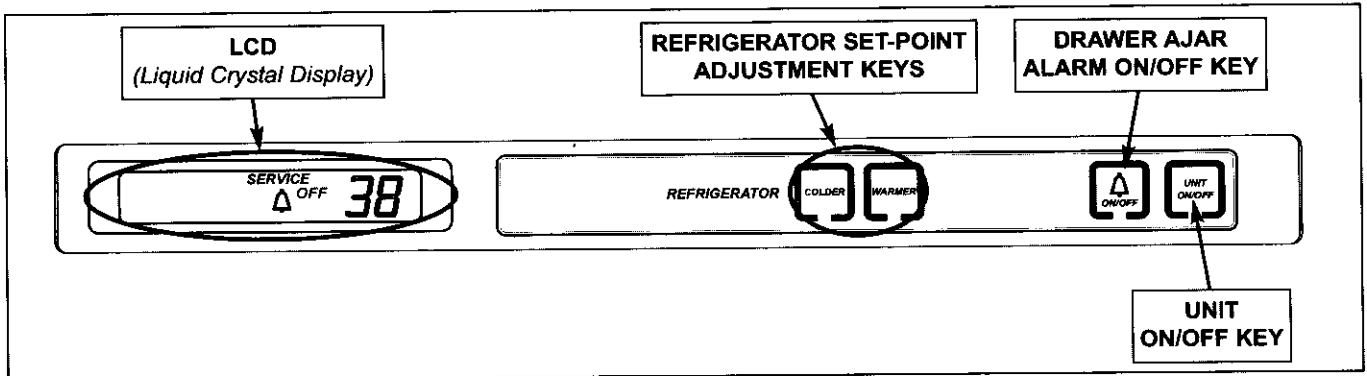

Figure 3-5. 700BR-3 Control Panel Layout

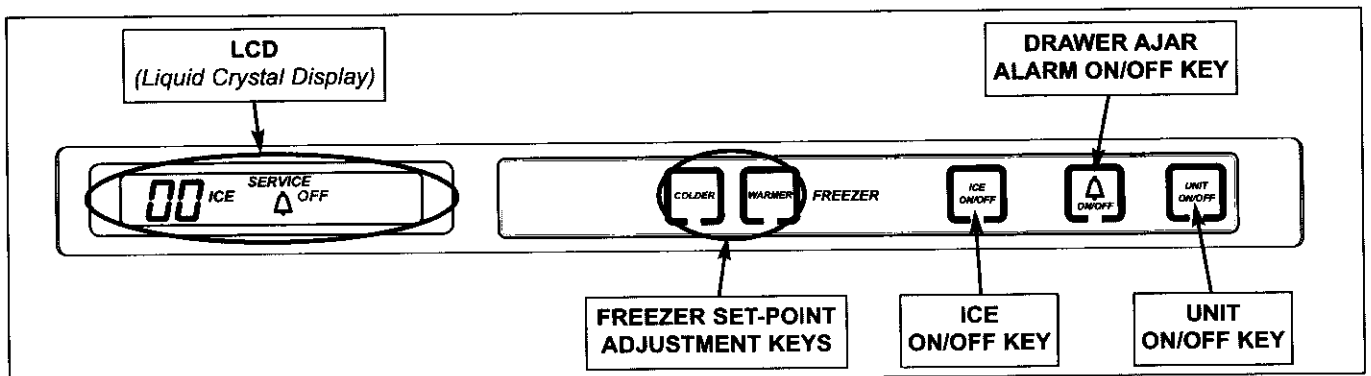

Figure 3-6. 700BFI-3 Control Panel Layout



BASIC ELECTRONIC CONTROL INPUT OPERATIONS

The following pages describe the basic input operations performed at A 700BCI-3 control panel (switching unit ON and OFF; adjusting set-point (temperature adjustment); switching ice maker system ON and OFF and enabling and disabling door ajar alarm feature. Please note that though possible to display temperatures in Fahrenheit or Celsius, in most cases Fahrenheit readings are shown.

Unit ON/OFF

All units are shipped in Off Mode. When power is supplied to the unit, a trace of the word "OFF" is visible on the LCD. By pressing the UNIT ON/OFF key (See Figure 3-7), power is allowed past the control board to the rest of the unit. This will be indicated by the unit lights illuminating and the LCD energizing.

NOTE: Whenever the unit is switched OFF using the UNIT ON/OFF key, a trace of the word "OFF" will be visible on the LCD as long as power is supplied to the unit. This differs in Sabbath Mode, which will be covered later.

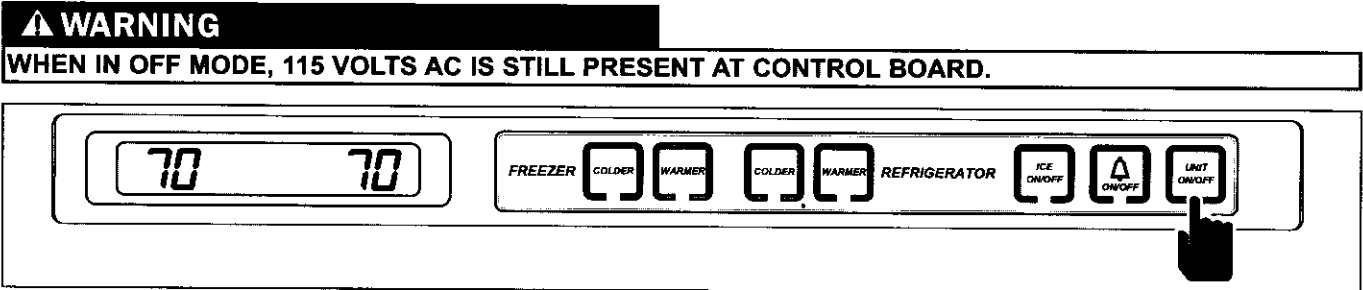

Figure 3-7. Unit ON/OFF - Press UNIT ON/OFF Key

Adjusting Set-Point (Temperature Adjustments)

To adjust set-points, press WARMER or COLDER keys on control panel in multiple key strokes until the desired set-point is achieved. One key stroke equals one degree change (Fahrenheit or Celsius). (See Figure 3-8)

NOTE: Temperature ranges are -5°F (-21°C) to +5°F (-15°C) in freezer zones, +34°F (+1°C) to +45°F (+7°C) in refrigerator zones, with initial set-points of 0°F (-18°C) and +38°F (+3°C), respectively.

NOTE: The initial stroke of the WARMER or COLDER keys will change previous set-point by one degree.

NOTE: The set-point will be displayed on the LCD for 10 seconds after the last WARMER or COLDER key stroke. After the 10 second delay, the zone temperature will be displayed. As the zone temperature changes, the temperature displayed on the LCD will change by no more than one degree per minute.

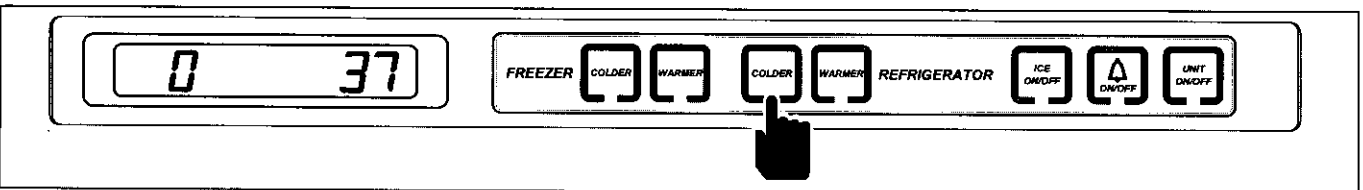

Figure 3-8. Adjusting Set-Point - Press WARMER or COLDER Key In Multiple Key Strokes

Icemaker System ON/OFF

All units with icemakers are shipped with the icemaker system switched OFF. By pressing the ICE ON/OFF key on the control panel, power is allowed to the icemaker system, and "ICE" appears on the LCD (See Figure 3-9). To disable the icemaker system, press the ICE ON/OFF key again and "ICE" will disappear from the LCD indicating the icemaker system is OFF.

NOTE: When unit is in "Sabbath Mode," icemaker system is disabled. Sabbath Mode will be covered later.

NOTE: To allow ice to freeze fully and reduce effects of low water pressure, power to the icemaker system is interrupted for 45 minutes after each ice harvest. This can be bypassed for service purposes by pressing the ICE ON/OFF key to switch the icemaker system OFF, then back ON.

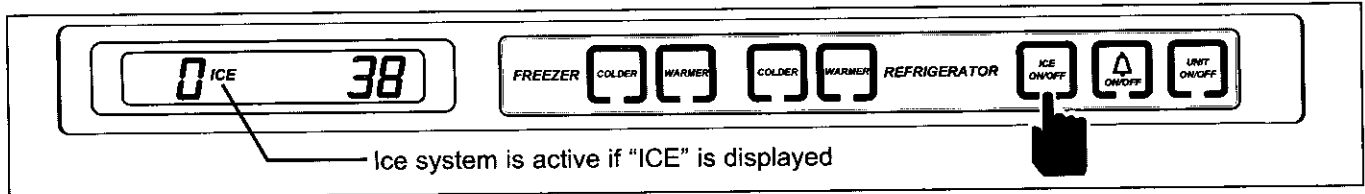

Figure 3-9. Icemaker System ON/OFF - Press ICE ON/OFF Key

Drawer Ajar Alarm ON/OFF

All units are equipped with a drawer ajar alarm feature. When activated, the alarm will alert a customer if a drawer is stuck open or accidentally left open. To enable the drawer ajar alarm feature, press the drawer ajar alarm bell ON/OFF key on the control panel. A bell icon will appear on the LCD indicating that the alarm feature is active. (See Figure 3-10) Now, if a drawer is open for 30 seconds, the bell icon will blink and the audible alarm will beep. To disable the drawer ajar alarm, simply press the drawer ajar alarm bell ON/OFF key and the bell icon on the LCD will disappear, indicating the alarm feature is OFF.

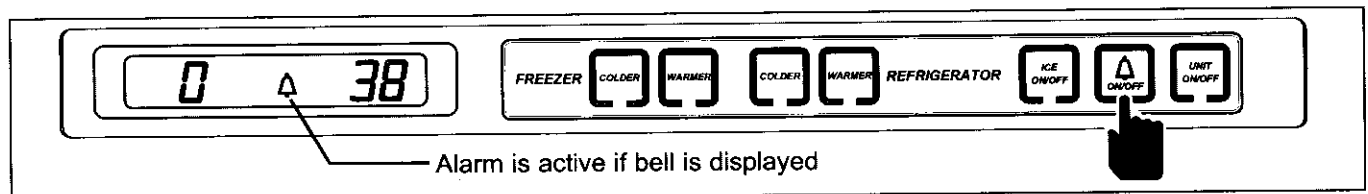

Figure 3-10. Drawer Ajar Alarm ON/OFF - Press Alarm Bell ON/OFF Key



UNIQUE ELECTRONIC CONTROL INPUT OPERATIONS

The following pages describe unique electronic control input operations performed at the control panel that you would not expect a customer to perform every day. The following input operations described are Temperature Unit Selection Mode, Sabbath Mode, Showroom Mode, and Manual Freezer Evaporator Defrost.

Temperature Units Selection Mode (Selecting Degrees Fahrenheit or Degrees Celsius Display)

The electronic control is initially set to display temperature in Fahrenheit (°F) units of measure. Units of measure can be converted from °F to °C (Celsius), and/or back again. This operation is called Temperature Units Selection.

NOTE: Temperature Units Selection must be performed within the first minute after switching the unit ON.

To convert the temperature units of measure from Fahrenheit readings to a Celsius readings, press and hold the door ajar alarm bell ON/OFF key and the UNIT ON/OFF key simultaneously for 5 seconds, then release the keys. " °C " will appear on the LCD indicating temperatures will now be displayed in Celsius units of measure. (See Figure 3-11) To convert back to Fahrenheit units of measure, repeat the steps above.

NOTE: Bottom Drawer must be closed. If not closed, unit will enter Model Configuration Mode.

NOTE: Temperature Units Selection Mode will end 10 seconds after the last key stroke.

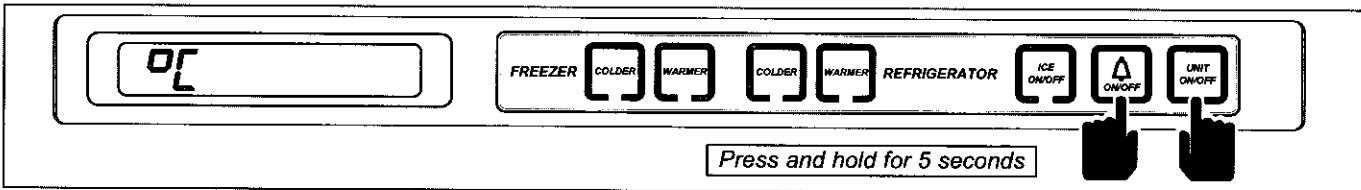

Figure 3-11. Converting Temperature Units of Measure (within first minute after switching unit ON) Press and Hold the Bell ON/OFF Key and UNIT ON/OFF Key for 5 Seconds

Sabbath Mode

Sabbath Mode was incorporated into the electronic control system for the observance of certain religious days. Initiating Sabbath Mode disables the LCD, lighting system, icemaker systems and the door ajar alarm feature.

To initiate Sabbath Mode, the unit must first be switched OFF using the UNIT ON/OFF key (See Figure 3-12), then press and hold the UNIT ON/OFF key for approximately 10 seconds, until the LCD and lights switch OFF (See Figure 3-13). To return to normal operation, press and release the UNIT ON/OFF key.

NOTE: During Sabbath Mode, the refrigerator fan and evaporator fan may function when drawers are open.

NOTE: During Sabbath Mode, the LCD is disabled and set-points cannot be changed.

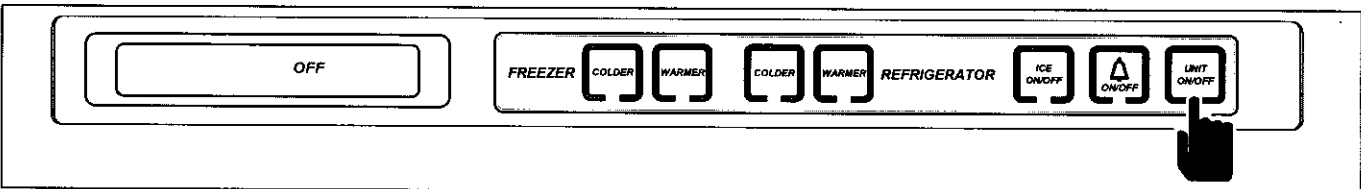

Figure 3-12. To Enter Sabbath Mode, Switch Unit OFF First

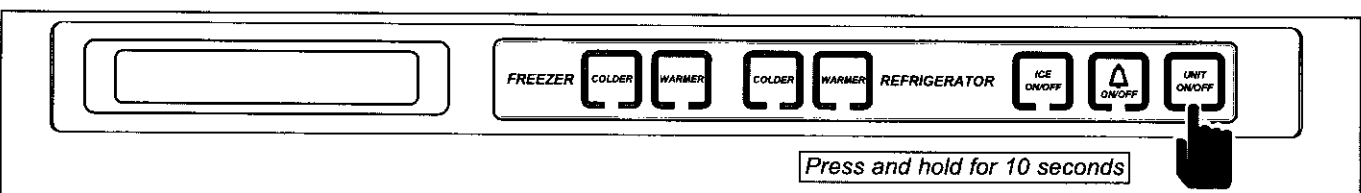

Figure 3-13. After Unit is Switched OFF, Press and Hold UNIT ON/OFF Key for 10 Seconds

Showroom Mode

Showroom Mode was incorporated into the electronic control system so that units could be displayed in a showroom setting. When in Showroom Mode, all cooling functions are disabled, but the lighting system and LCD remain active.

To initiate Showroom Mode, the unit must first be switched OFF using the UNIT ON/OFF key (See Figure 3-14). With the unit switched OFF, press and hold either pair of WARMER and COLDER keys, then press the UNIT ON/OFF key, then release all three keys (See Figure 3-15).

To return unit to normal operating condition, repeat the steps above.

NOTE: Always recheck set-points after returning unit to normal operating condition.

NOTE: It is possible to determine if a unit is in Showroom Mode by initiating Diagnostic Mode. If "Sr" is observed in the left temperature display area during Diagnostic Mode, the unit is in Showroom mode. Initiating Diagnostic Mode is covered later in this section.

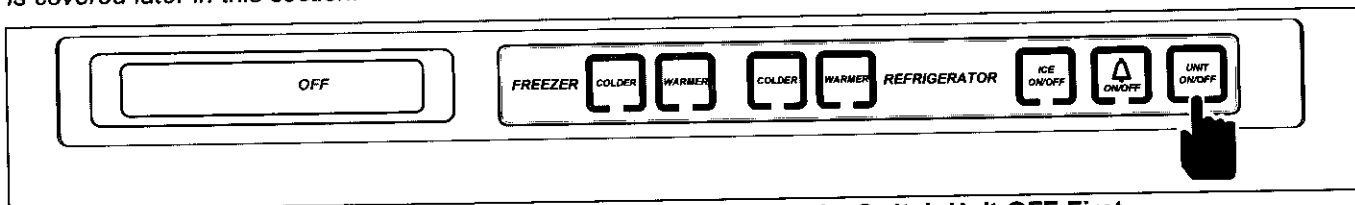

Figure 3-14. To Enter (or Exit) Showroom Mode, Switch Unit OFF First

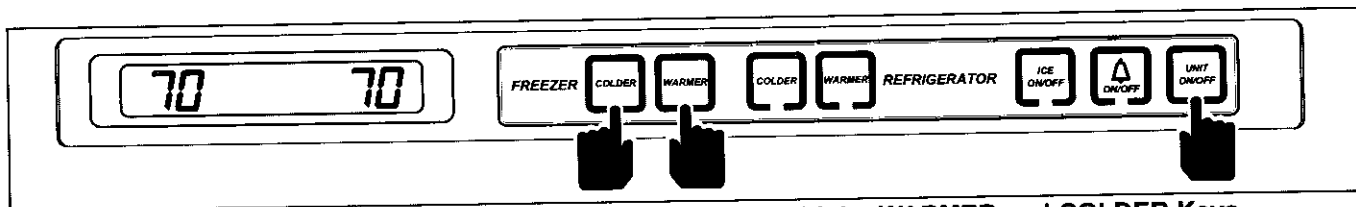

Figure 3-15. After Unit is Switched OFF, Press and Hold the WARMER and COLDER Keys, Then Press the UNIT ON/OFF Key

Manual Freezer Evaporator Defrost

Manual Freezer Evaporator Defrost was incorporated into the electronic control to assist in servicing the appliance. To manually defrost the freezer evaporator, press and hold the ICE ON/OFF key for 5 seconds (See Figure 3-16).

NOTE: Manual Freezer Evaporator Defrost will not operate if unit is in Sabbath Mode.

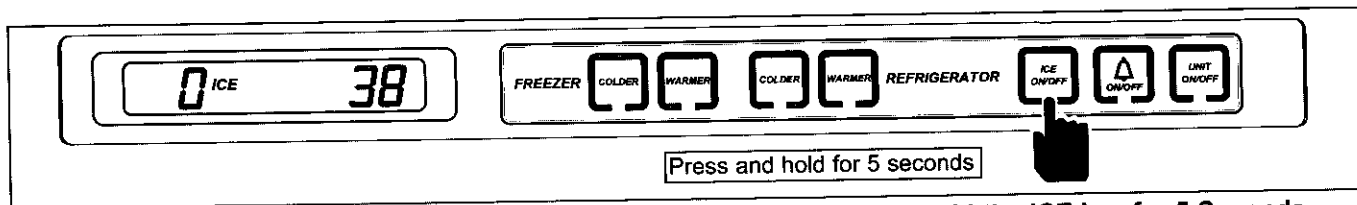

Figure 3-16. Initiate Manual Freezer Evaporator Defrost - Press and Hold the ICE key for 5 Seconds



FUNCTIONS OF ELECTRONIC CONTROL SYSTEM

The following few pages explain monitoring, regulating and controlling functions of the electronic control system.

Display Zone Temperatures

The temperature signals from the thermistors in the refrigerator and freezer compartments are monitored by the microprocessor and then displayed on the LCD. Though the compartment air temperature does fluctuate, the LCD displays the average temperature (See Figure 3-17).

NOTE: If zone temperature changes, temperature display will change by one degree per minute.

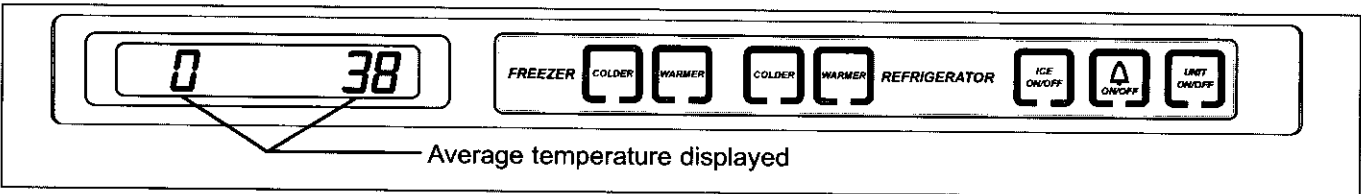

Figure 3-17. Display Zone Temperatures

Supply Power to the Lighting System

Power is supplied to the lighting system through the control board when the unit is switched ON by pressing UNIT ON/OFF key. With a drawer open, the light switch allows power to the light. (See Figure 3-18).

NOTE: Power to the lights is monitored by the microprocessor to control the door ajar alarm feature and to help control the operation of the evaporator fan and/or refrigerator compartment fan.

NOTE: When in Sabbath Mode, lighting system is disabled. Sabbath Mode will be covered later.

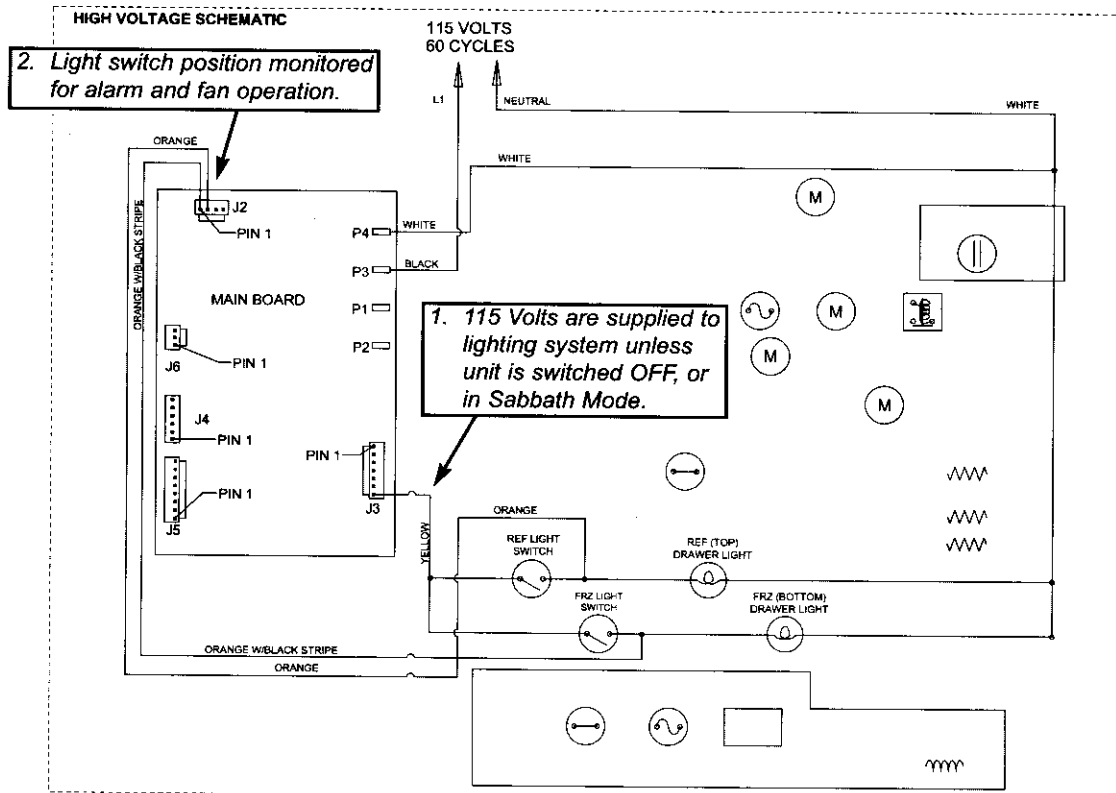

Figure 3-18. 700BCI-3 Signal Trace Schematic (High Voltage) of Lighting System

Regulate Freezer Zone Temperature (700BCI-3, 700BFI-3)

When the thermistor in the freezer compartment reaches high off-set temperature, calling for cooling, the compressor and condenser fan are energized, but the evaporator fan is not allowed to run until the thermistor on the evaporator reaches 35°F (2°C). (See Figure 3-19)

If either drawer is opened while the evaporator fan is operating, the microprocessor will detect the power signal to the lights and cut power to the fan.

Though compartment air temperatures will fluctuate, LCD displays average temperature.

NOTE: If compartment temperature exceeds either high or low offset (Ex: drawer is left open), temperature display will change by one degree per minute.

NOTE: If freezer compartment thermistor is faulty, compressor operation defaults to 20 minutes ON, 20 minutes OFF cycling, EE appears in left of LCD, SERVICE will flash and Error Code 07 will be logged.

NOTE: If evaporator thermistor is faulty, the compressor will be energized after the dwell time and the evaporator fan will be energized 3 minutes later. SERVICE will flash and Error Code 08 will be logged.

NOTE: When in Sabbath Mode, the freezer compartment thermistor still controls compressor operation, except there is a random 15 to 25 second delay before the compressor is energized.

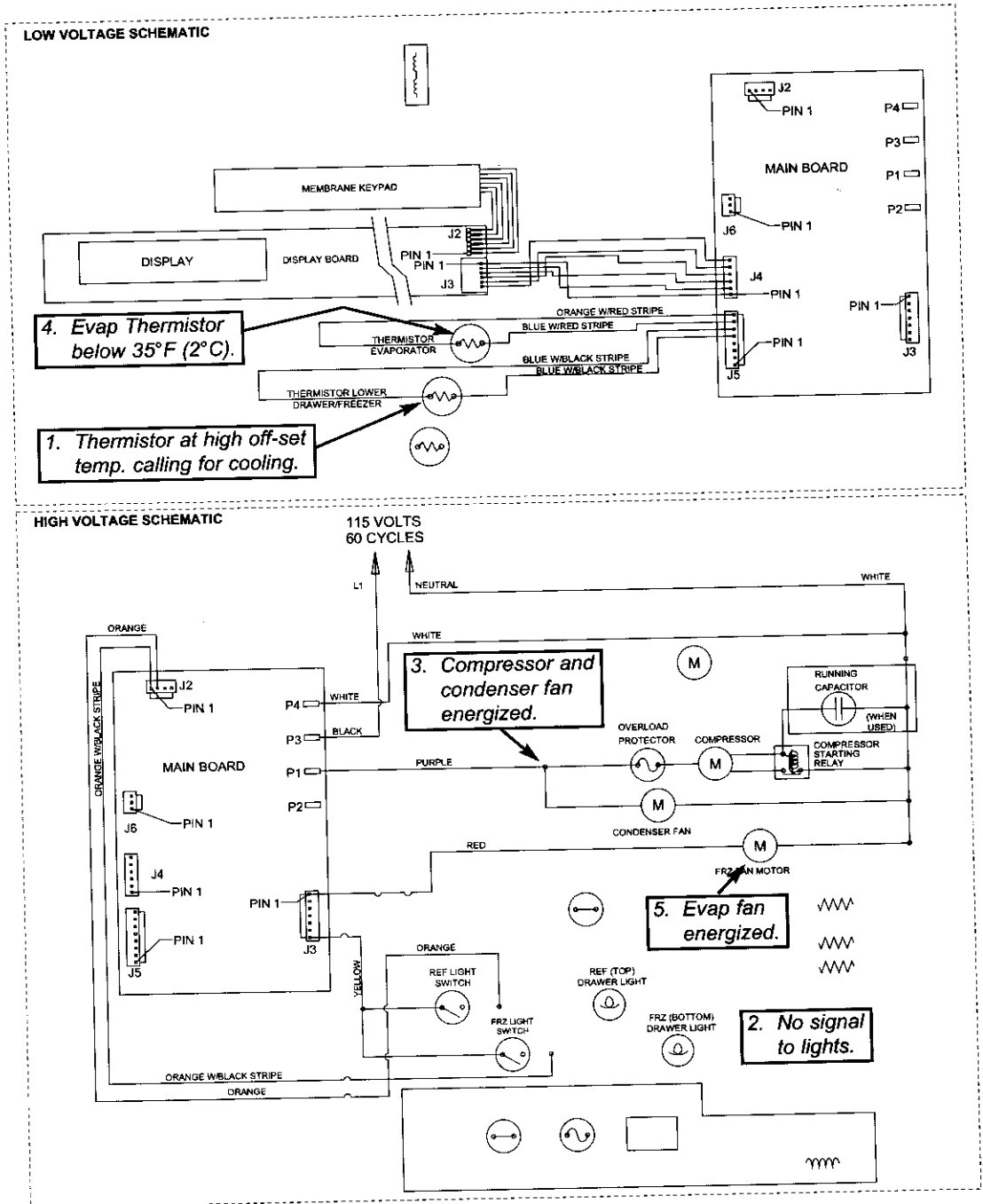

Figure 3-19. 700BCI-3 Signal Trace - Regulate Freezer Zone

Regulate Refrigerator Zone Temperature (700BCI-3)

When the thermistor in refrigerator compartment reaches high off-set temperature, calling for cooling, the refrigerator compartment fan is energized and microprocessor sends an 18 Volt pulse signal to the air baffle control to open, regardless of operational state of the compressor. Whenever the fan is energized, the microprocessor repeats sending a pulse signal every 5 minutes to the air baffle control to open. (See Figure 3-20)

If either drawer is opened while the refrigerator compartment fan is operating, the microprocessor will detect power to the lights and cut power to the fan.

When thermistor in refrigerator compartment reaches low off-set temperature, power to refrigerator compartment fan is cut and micro-processor sends an 18 Volt pulse signal to the air baffle control to close. When refrigerator compartment fan is off, micro-processor repeats sending a pulse signal every 5 minutes to the air baffle control to close.

Though compartment air temperatures fluctuates, the LCD displays average temperature.

NOTE: If compartment temperature exceeds either high or low offset (Ex: drawer is left open), temperature display will change by one degree per minute.

NOTE: If refrigerator compartment thermistor is faulty, compartment fan defaults to 20 minutes ON, 40 minutes OFF cycling, EE appears in right of LCD, SERVICE will flash and Error Code 05 will be logged.

NOTE: When in Sabbath Mode, refrigerator compartment thermistor still controls fan operation except there is a random 15 to 25 second delay before the fan is energized.

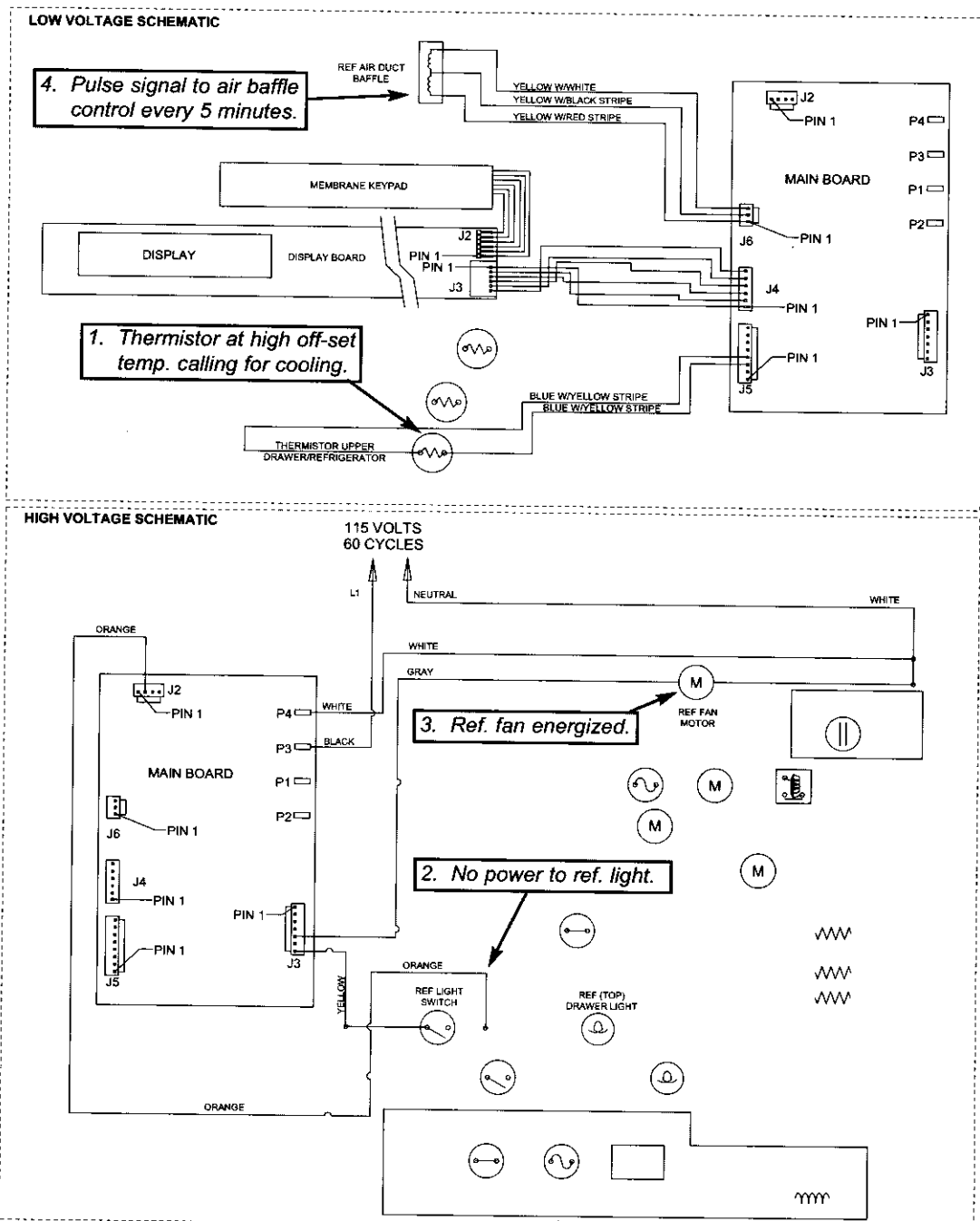

Figure 3-20. 700BCI-3 Signal Trace - Regulate Refrigerator Zone

Regulate Refrigerator Zone Temperature (700BR-3)

When the thermistor in the refrigerator compartment reaches high off-set temperature, calling for cooling, the evaporator fan is energized, but the compressor and condenser fan are not allowed to run until the thermistor on the evaporator reaches 38°F (3°C). (See Figure 3-21)

If either drawer is opened while the evaporator fan is operating, the microprocessor will detect the power signal to the lights and cut power to the fan.

Though compartment air temperatures will fluctuate, LCD displays average temperature.

NOTE: If compartment temperature exceeds either high or low offset (Ex: drawer is left open), temperature display will change by one degree per minute.

NOTE: If refrigerator compartment thermistor is faulty, compressor operation defaults to 20 minutes ON, 40 minutes OFF cycling, EE appears in left of LCD, SERVICE will flash and Error Code 05 will be logged.

NOTE: If evaporator thermistor is faulty, the compressor will not energize until zone air temperature exceeds high offset by 5°F (3°C). SERVICE flashes and Error Code 06 is logged.

NOTE: When in Sabbath Mode, the refrigerator compartment thermistor still controls compressor operation, except there is a random 15 to 25 second delay before the compressor is energized.

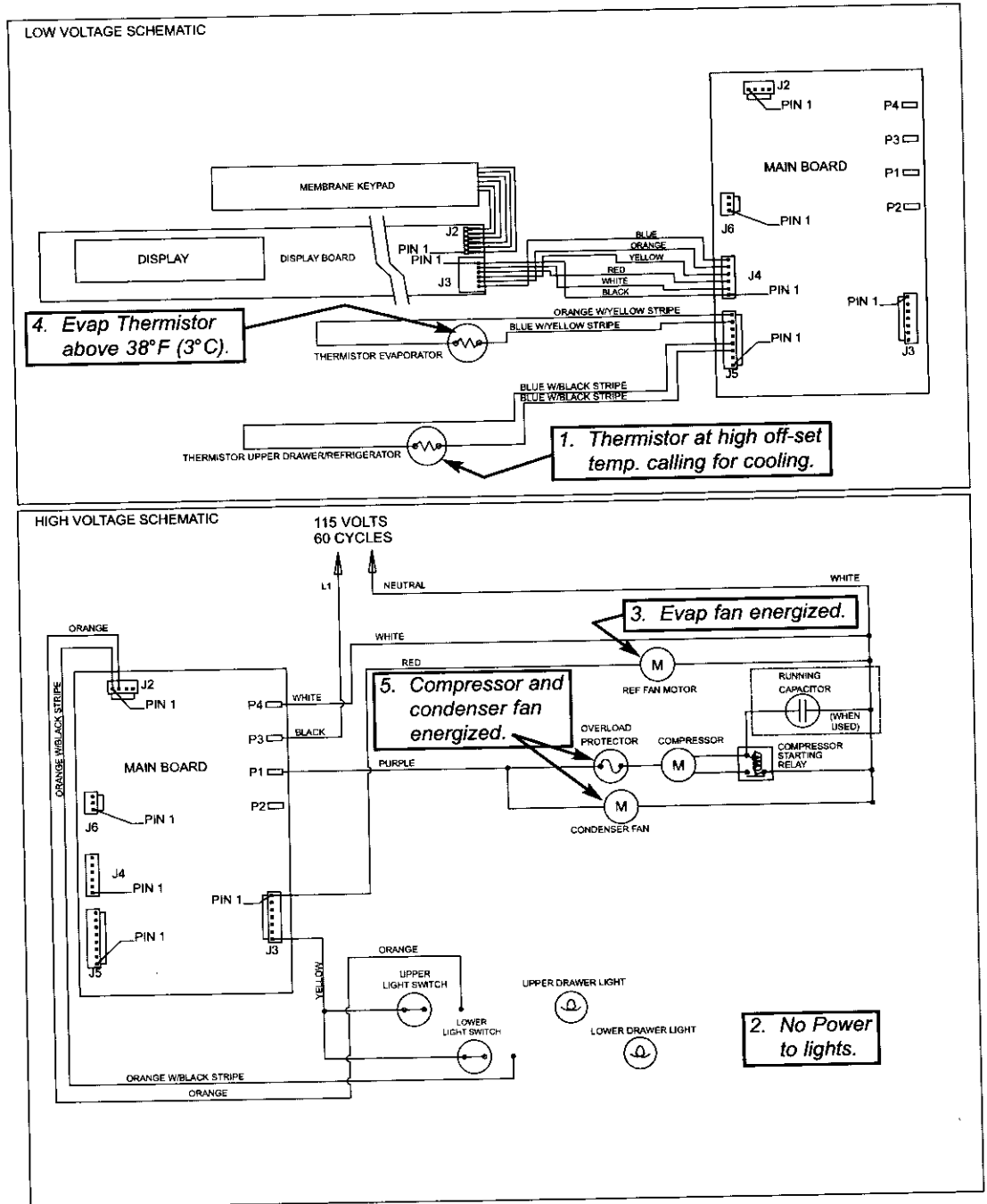

Figure 3-21. 700BR-3 Signal Trace - Regulate Refrigerator Zone



Monitor and Control "Adaptive Defrost" (700BCI-3, 700BF1-3)

Initially, the compressor will cycle-run for 12 hours, after which the microprocessor sends a signal to the defrost relay on the control board to close. This supplies power to the defrost heater, drain tube heater and fill tube heater. At the same time the compressor, condenser fan and evaporator fan are switched off.

With the "Adaptive Defrost" technique, the length of time that the defrost heater stays on to open the defrost terminator bimetal ($70^{\circ}\text{F}/21^{\circ}\text{C}$), is observed by the microprocessor via the grey w/white stripe wire to J2.

The microprocessor then determines the number of hours before the next defrost. If the heater stays on for a shorter time than specified, the microprocessor increases the next defrost interval. If the heater stays on longer than specified, the electronic control decreases the next defrost interval. (See Figure 3-13) This is an ongoing process whereby the defrost time and the defrost interval will vary by unit use.

NOTE: A 5 minute time delay/dwell follows all defrosts, during which the drain tube heater and fill tube heater remain energized. At the end of the 5 minute dwell, the drain tube heater and fill tube heater are switched off, then the compressor and condenser fan are energized, but the evaporator fan will not be energized until the evaporator temperature falls below 35°F (2°C).

NOTE: The minimum defrost interval is 6 hours of compressor run time; the maximum defrost interval is 42 hours of compressor run time; the maximum defrost duration is 25 minutes plus 5 minute dwell.

NOTE: If the grey w/white wire defrost sensing line is open, defrost operation defaults to 25 minute defrost time and 6 hour build time, and Error Code 22 is logged. If the evaporator thermistor detects an underheat or overheat situation at the same time, Error Codes 20 or 23 will be registered, respectively.

NOTE: During defrost, the display temperature is locked.

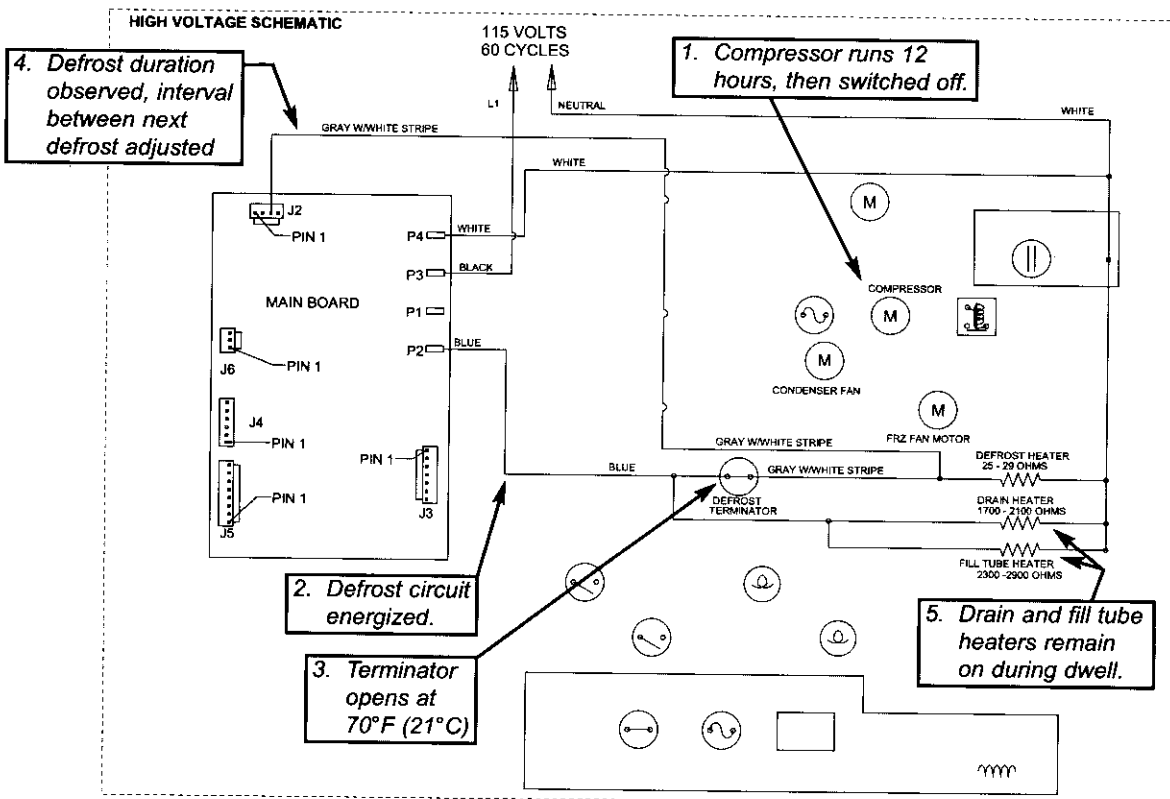

Figure 3-22. 700BCI-3 Signal Trace Schematic - Adaptive Defrost

Monitor and Control Refrigerator Fan-Assisted, Off-Cycle Defrost (700BR-3)

Temperature signals from refrigerator evaporator's thermistor's are observed by the microprocessor. During off cycle defrost, if a refrigerator zone temperature reaches high offset (calling for cooling) before evaporator temperature rises to 38°F (3°C), no power will be supplied the the compressor. But, the the zone evaporator fan will switch ON. Once the evaporator temperatur reaches 38°F (3°C), normal cooling functions begin. (See Figure 3-23).

NOTE: If refrigerator compartment thermistor is faulty, compressor operation defaults to 20 minutes ON, 40 minutes OFF cycling, EE appears in left of LCD, SERVICE will flash and Error Code 05 will be logged.

NOTE: If evaporator thermistor is faulty, the compressor will not energize until zone air temperature exceeds high offset by 5°F (3°C). SERVICE flashes and Error Code 06 is logged.

NOTE: When in Sabbath Mode, the refrigerator compartment thermistor still controls compressor operation, except there is a random 15 to 25 second delay before the compressor is energized.

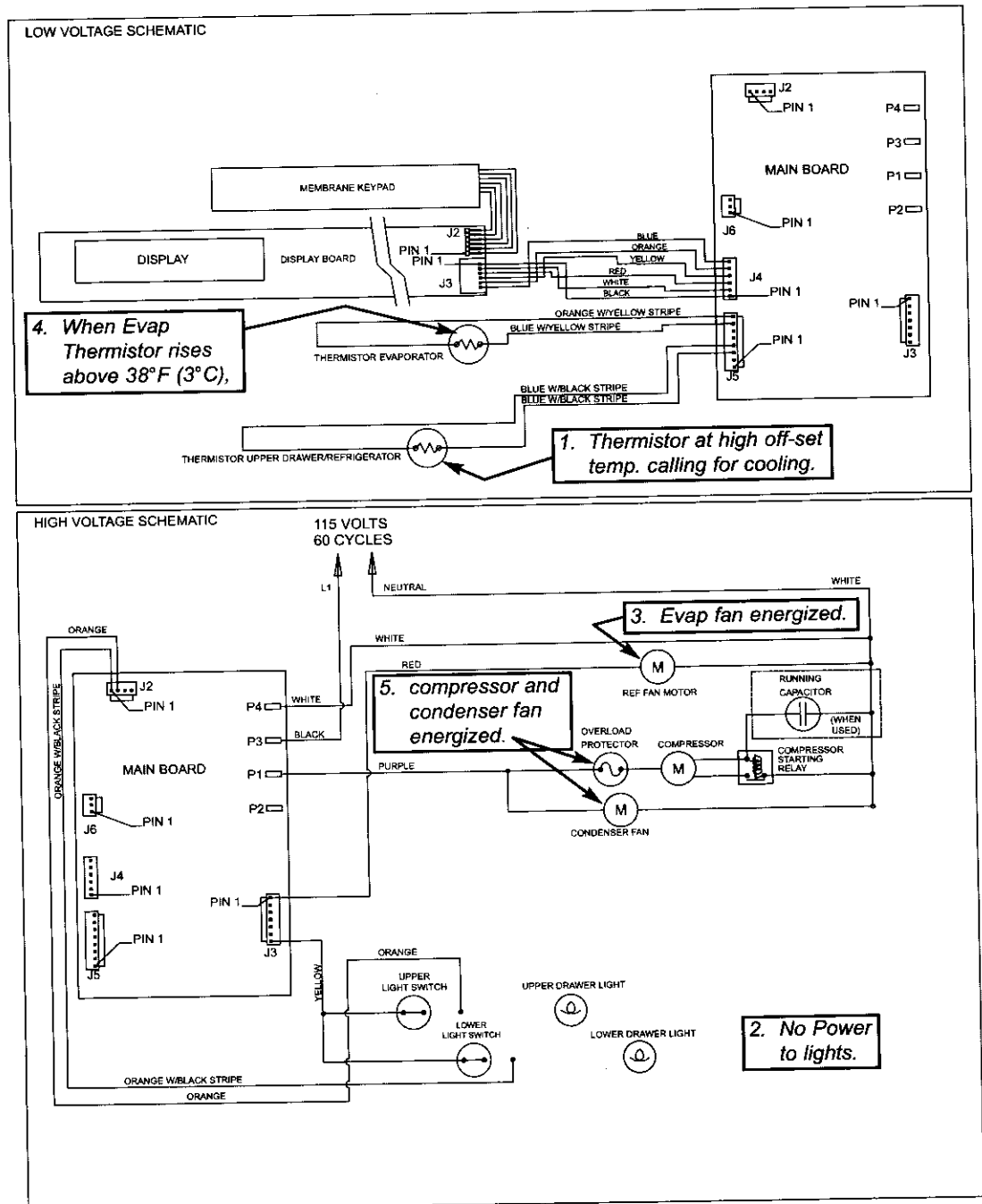

Figure 3-21. 700BR-3 Signal Trace - Regulate Refrigerator Zone



Monitor Compressor Run Duration, Displays If Service is Needed

The microprocessor observes the state of the compressor relay to determine the length of compressor run time (See Figure 3-22). If the compressor runs 100% (Freezer = 6 hours, Refrigerator = 4 hours), an error code is logged (EC 40), and defrost will be initiated, but SERVICE will not flash.

If several 100% compressor run periods occur, and a drawer was not opened during the last excessive compressor run period, and the temperature in the zone is not able to fall half way between the set point and the low off-set, then SERVICE will flash (See Figure 3-23).

NOTE: To clear a flashing SERVICE and error codes, the problem must be corrected, then the Alarm ON/OFF key pressed for 15 seconds. Failure to clear an error code will cause SERVICE to display constant.

NOTE: If the unit is ever switched OFF then back ON, the compressor will not energize for at least 3 minutes. This 3 minute minimum OFF time is used to protect the compressor and its electricals.

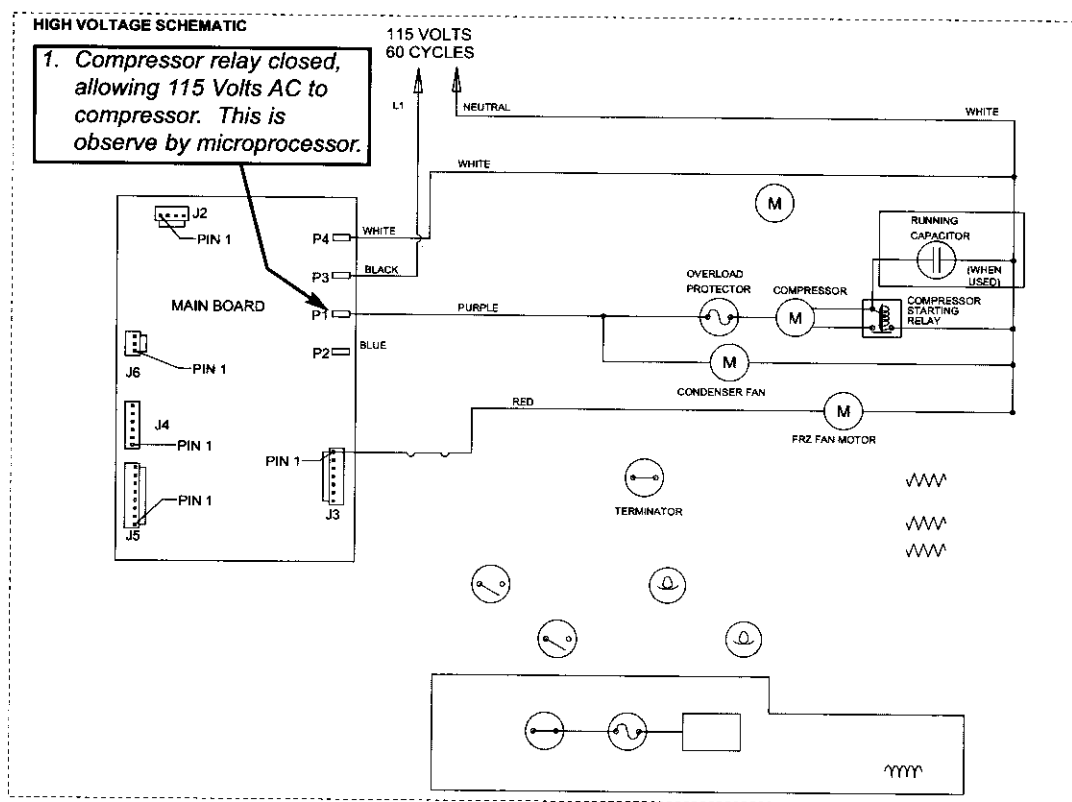

Figure 3-22. 700BCI-3 Signal Trace Schematic - Compressor Run

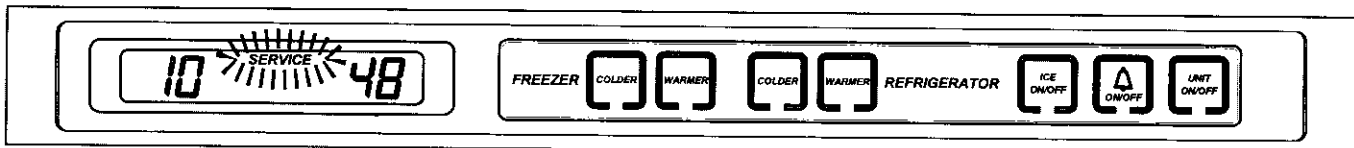

Figure 3-23. Service Flashing if several 100% compressor run periods occurred, a drawer was not opened during last excessive run period, and temperature is not able to fall half way between set point & low off-set.

Monitor Icemaker System and Display If Service is Needed

The microprocessor observes the power supplied to the icemaker water valve solenoid. If the solenoid is energized for more than 15 seconds, power to the icemaker system is disabled for 24 hours and an error code is logged (EC 30). (See Figure 3-24) If this happens five consecutive times, ICE and SERVICE on the LCD will flash and the ICE ON/OFF key will be disabled (See Figure 3-25).

NOTE: To clear the ICE and SERVICE error indicators, and reactivate the ICE ON/OFF key, the problem must be corrected, then the unit must be switched OFF and back ON, and the Alarm key must be pressed for 15 seconds to clear the Error Code.

NOTE: To allow ice to freeze fully and reduce effects of low water pressure, power to the icemaker system is interrupted for 45 minutes after each ice harvest. This can be bypassed for service purposes by switching the icemaker system OFF, then back ON by pressing the ICE ON/OFF key.

NOTE: When in Sabbath Mode, icemaker system is disabled. Sabbath Mode will be covered later.

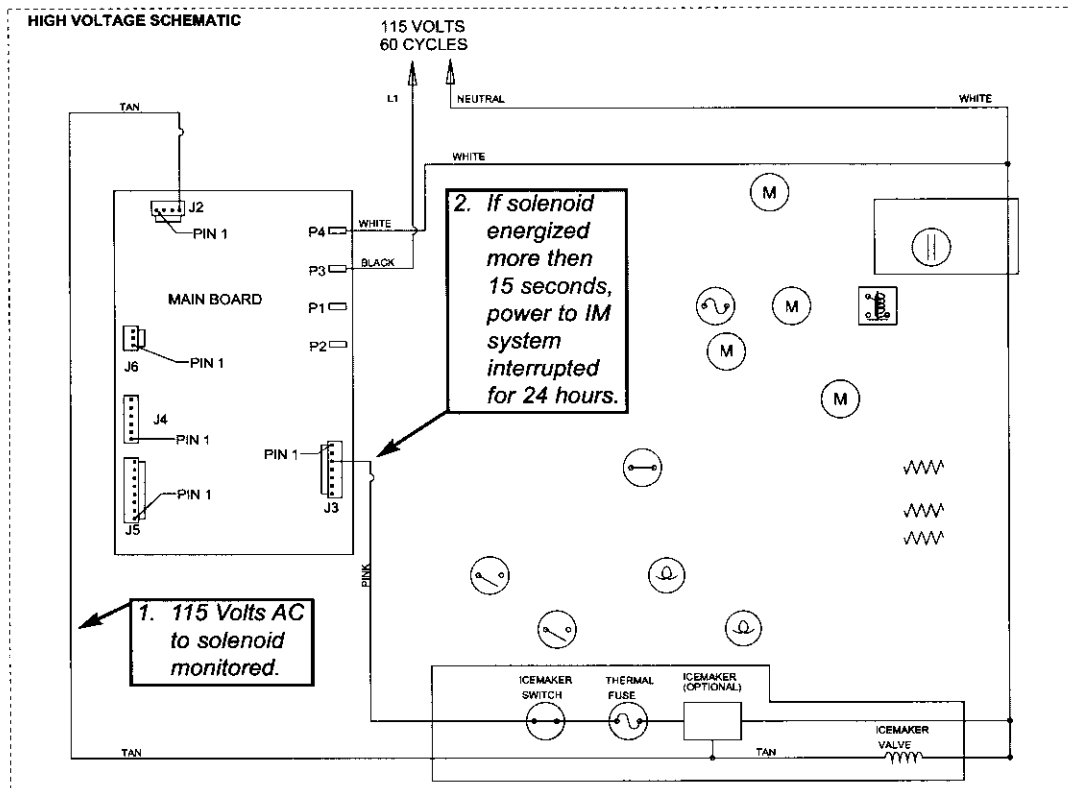

Figure 3-24. 700BCI-3 Signal Trace Schematic - Icemaker Operation and Solenoid Monitoring

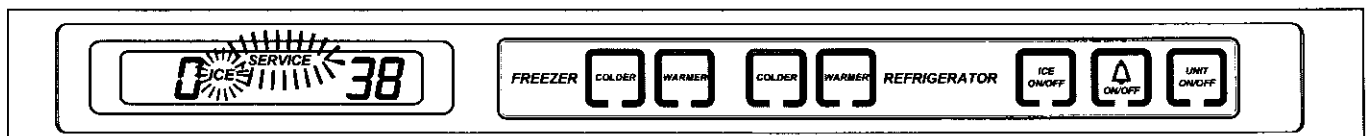

Figure 3-25. ICE & SERVICE Flashing if solenoid energized 15 seconds, every 24 hours, 5 consecutive times



POSSIBLE ERROR INDICATORS

The diagrams on this page illustration what a customers may see on LCD if a problem/error exists with the unit.

NOTE: To clear indicators and error codes, problem must be corrected then press bell ON/OFF key for 15 seconds.

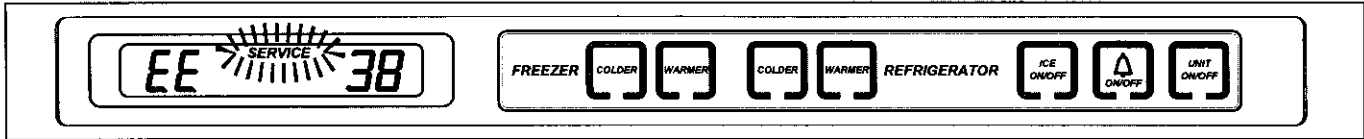

Figure 3-26.

“EE” Displayed at Left & “SERVICE” Flashing = Freezer Compartment Thermistor (or its Wiring) Fault

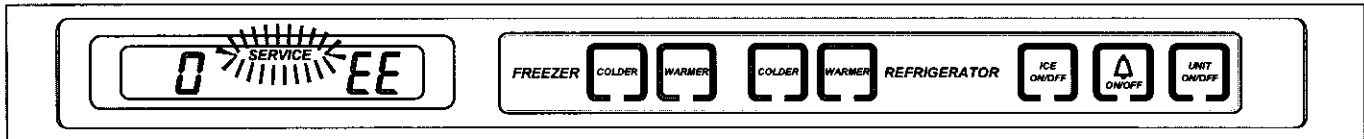

Figure 3-27.

“EE” Displayed at Right & “SERVICE” Flashing = Refrigerator Compartment Thermistor (or its Wiring) Fault

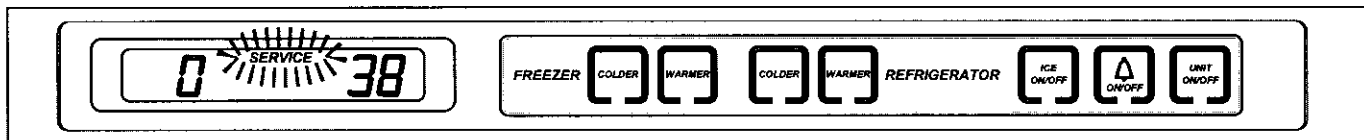

Figure 3-28.

Service Flashing = Evaporator Thermistor (or its Wiring) Fault

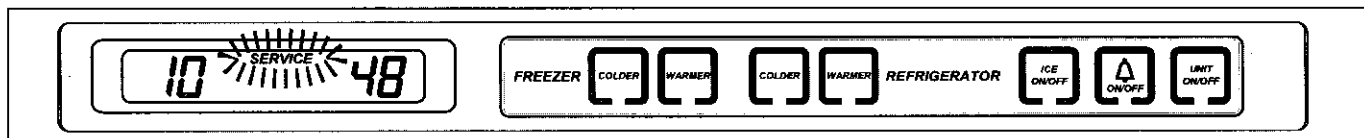

Figure 3-29.

Service Flashing = Several 100% run periods, a drawer was not open during last 100% run period, and zone temperature not able to fall half way between set point and low off-set.

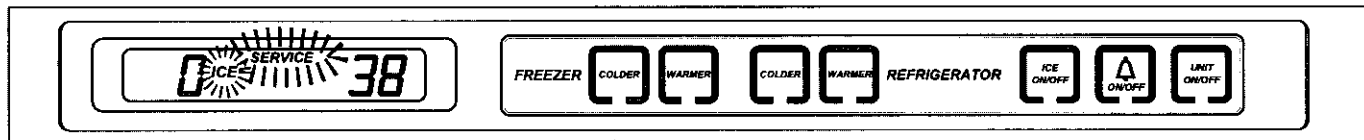

Figure 3-30.

“ICE” and “SERVICE” Flashing = Solenoid Energized 15 Seconds, Every 24 Hours, 5 Consecutive Times

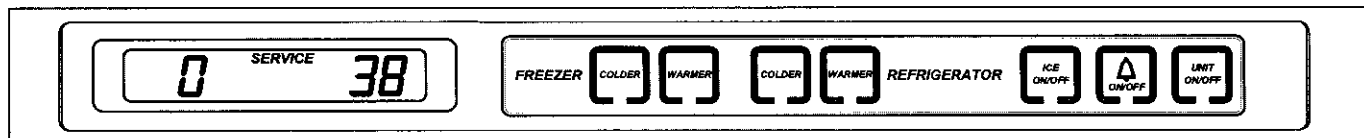

Figure 3-31.

“SERVICE” Steady, not Flashing = Error Codes Observed in Diagnostic Mode, but not Cleared

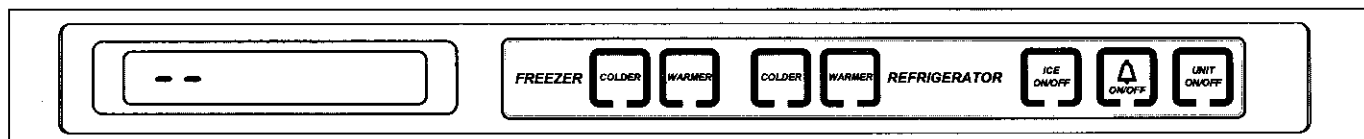

Figure 3-32.

“- . -” Double Dashes Displayed = Model Configuration was not Performed

ELECTRONIC CONTROL TROUBLESHOOTING INPUT OPERATIONS

The following few pages explain troubleshooting input operations performed at the control panel. The input operations described are Diagnostic Mode, Manual Component Activation Mode and Temperature Log Recall.

Diagnostic Mode

Initiating Diagnostic Mode allows the Service Technician to observe real-time temperature readings from all thermistors without temperature averaging.

To initiate Diagnostic Mode, the unit must be ON, then press and hold either COLDER key, and press the UNIT ON/OFF key, then release both keys (See Figure 3-33). The left display area will show the real-time temperature of the thermistor, the right display area will show the thermistor location code, and all LCD indicators will illuminate. Pressing either COLDER key while in Diagnostic Mode will toggle forward to the next thermistor location (See Figures 3-34 & 3-35), while pressing either WARMER key while in Diagnostic Mode will toggle backward to the previous thermistor location.

NOTE: If the COLDER and UNIT ON/OFF keys are pressed and held for 10 seconds, Manual Component Activation Mode will be initiated (this is covered later in the section).

NOTE: Diagnostic Mode will end 20 seconds after the last key stroke.

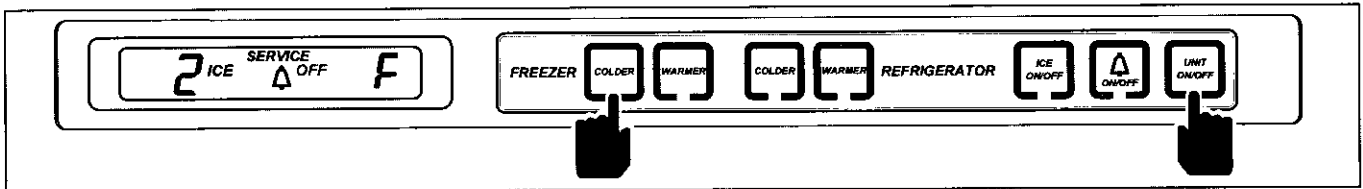

Figure 3-33. Initiate Diagnostic Mode - Press and Hold Either COLDER Key, Then UNIT ON/OFF Key ("F" Indicates Freezer Compartment)

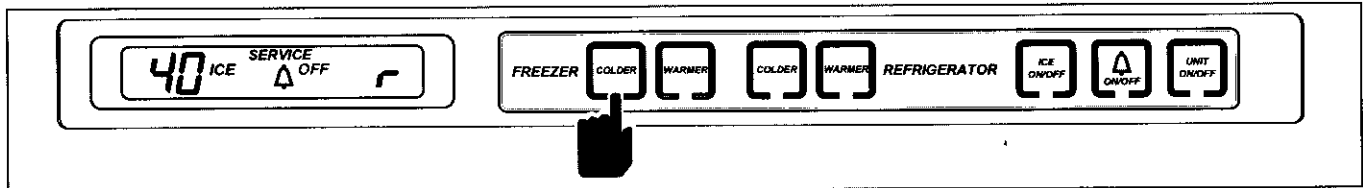

Figure 3-34. Toggle Through Temperature Readings - Press Either COLDER Key ("r" Indicates Refrigerator Compartment)

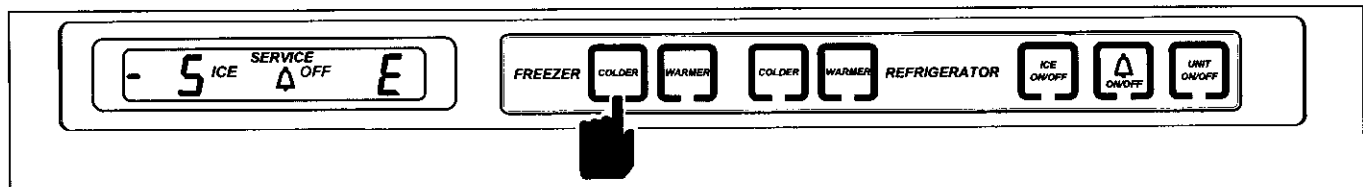

Figure 3-35. Toggle Through Temperature Readings - Press Either COLDER Key ("E" Indicates Evaporator)

BCI-3 Thermistor Code Table		BR-3 Thermistor Code Table		BFI-3 Thermistor Code Table	
THERMISTOR LOCATION	CODE	THERMISTOR LOCATION	CODE	THERMISTOR LOCATION	CODE
Freezer Compartment	F	Refrigerator Compartment	r	Freezer Compartment	F
Refrigerator Compartment	r	Evaporator	E	Evaporator	E
Evaporator	E				



Diagnostic Mode Indicators

If "EE" is observed in left display area during Diagnostic Mode, the thermistor in that location is open or shorted, or there is a break in that thermistor's wiring (See Figure 3-36).

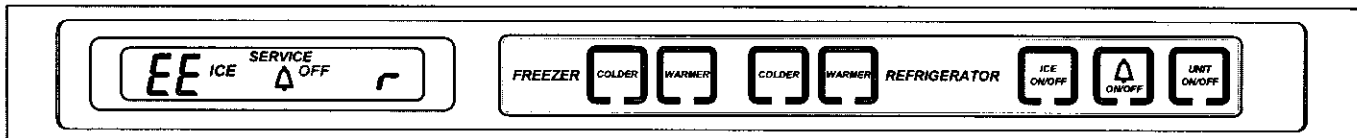

Figure 3-36. "EE" Observed in Diagnostic Mode = Thermistor Fault in Location Indicated by Code

If "Sr" is observed at left display area during Diagnostic Mode, the unit is in Showroom Mode, which was explained earlier in this section (See Figure 3-37).

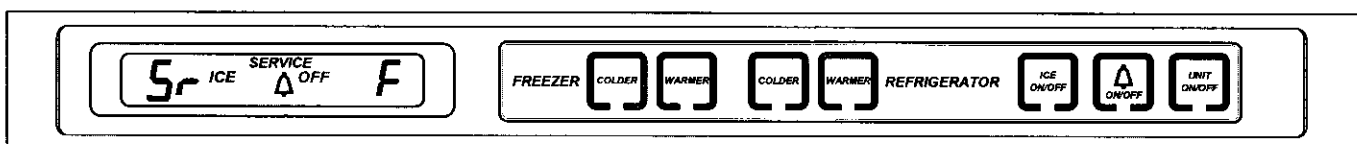
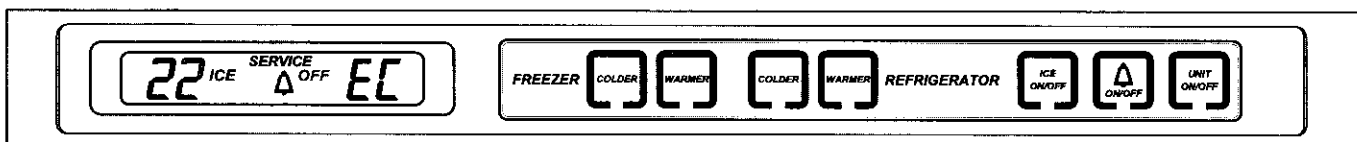

Figure 3-37. "Sr" Observed While in Diagnostic Mode = Unit is in Showroom Mode

If "EC" is observed in the right display area during Diagnostic Mode, the numbers at left are "Error Codes" (See Figure 3-38). Error Codes indicate problems registered by specific components. If error codes are registered, they will appear before temperature readings and can be toggled through with the temperature readings as described on the previous page. (See Error Code Table below and instructions on clearing Error Codes on next page.)



**Figure 3-38. "EC" Observed While in Diagnostic Mode = Error Code
(See table below & how to clear Error Codes on next Page)**

700BCI-3 Error Code Table	
CODE	INDICATION
05	Refrig. cabinet thermistor read open or shorted for 10+ seconds, or repeatedly read erratic temp's
07	Freezer cabinet thermistor read open or shorted for 10+ seconds, or repeatedly read erratic temp's
08	Freezer evaporator thermistor read open or shorted for 10+ seconds, or repeatedly read erratic temp's
20	Defrost under-heat with no voltage feedback through Gray/White wire at defrost start
21	Defrost overheat
22	No voltage feedback through Gray/White wire at defrost start
23	Defrost overheat with no voltage feedback through Gray/White wire at defrost start
24	Defrost under-heat
30	Excessive Icemaker Water Valve Solenoid Activation (Exceeded 15 Seconds)
40	Excessive Freezer Compressor Run
50	Excessive Refrigerator Compressor Run (Model 700BCI) / Excessive Refrigerator Fan Run (Model 700BR)



If Error Codes are observed in Diagnostic Mode, a non-flashing SERVICE icon will appear on the LCD when Diagnostic Mode ends, indicating error codes are still stored (See Figure 3-39). To clear a non-flashing SERVICE icon and the error codes, the problem must be corrected and the unit must be ON, then the door ajar alarm bell ON/OFF key must be pressed and held for 15 seconds. The control will emit a short "beep" when the SERVICE icon and error codes are cleared. (See Figure 3-40)

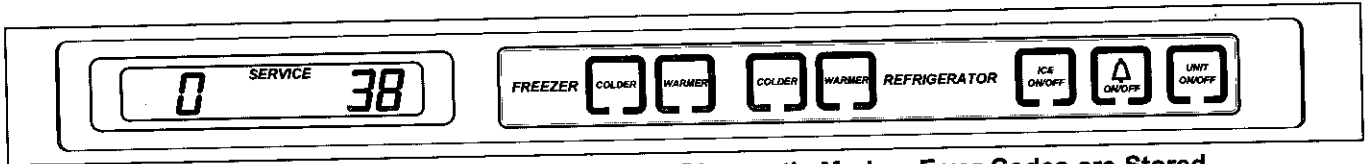

Figure 3-39. Non-flashing SERVICE after Diagnostic Mode = Error Codes are Stored

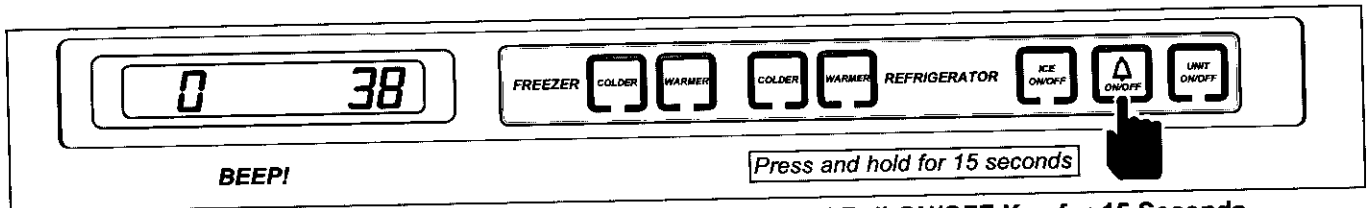

Figure 3-40. Clear Non-flashing SERVICE - Press & Hold Bell ON/OFF Key for 15 Seconds

Manual Component Activation Mode

Manual Component Activation Mode energizes the cooling system for 5 minutes, allowing a Service Technician to check for proper voltage readings at activated components without having to wait for the zone to call for cooling.

To initiate Manual Component Activation Mode the unit must be ON, then press and hold the desired COLDER key and the UNIT ON/OFF key for 10 seconds (See Figure 3-41). All cooling functions for that zone will begin and the zone compartment temperature will be displayed in the left display area of the LCD and the right display area will show the thermistor location.

NOTE: If a COLDER and the UNIT ON/OFF keys are pressed and held for less than 10 seconds, Diagnostic Mode will be initiated. This was covered earlier in the section.

NOTE: It is possible to toggle through the other temperature readings as in Diagnostic Mode, but in this case the temperature readings will last for 5 minutes rather than twenty seconds.

NOTE: The compressor overload could prevent the compressor from energizing.

NOTE: Manual Component Activation Mode will end 5 minutes after it is initiated. It is possible to end this 5 minute run time and return to normal operation by switching the unit OFF then back ON. If this is done, note that the electronic control will observe a 3 minute minimum compressor OFF time when the unit is switched back ON. This is to protect the compressor and its electricals.

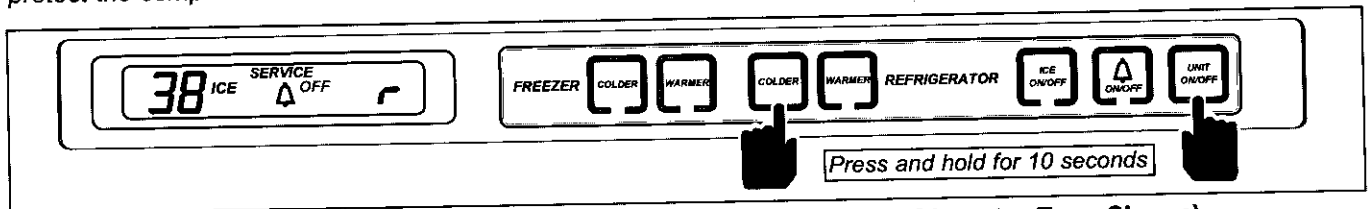

Figure 3-41. Initiate Manual Component Activation Mode (Refrigerator Zone Shown) - Press and Hold Desired COLDER Key and UNIT ON/OFF Key for 10 Seconds

Temperature Log Recall Mode

The electronic control system is equipped with a temperature history data storage system. This system logs/stores the average temperature of each individual thermistor every two hours, along with any event indicators (explained later in this section), that may have occurred. These two-hour periods are referred to as "indexes". Up to 168 indexes can be stored for each compartment, making it possible to observe the preceding fourteen days of the unit's temperature history (*each index equals 2 hour temperature average; 2 hours X 168 indexes = 14 days*). After 168 indexes are stored, each new index will bump the oldest index. Index number "1" being the most recent two-hour temperature average and index number "168" being the oldest. Accessing this temperature history data so it can be viewed on the LCD is accomplished by initiating Temperature Log Recall Mode.

There are two ways to initiate Temperature Log Recall Mode. One allows viewing of compartment temperature history only (see below), the other allows viewing of compartment temperature history and evaporator temperature history (see following page).

Initiate Temperature Log Recall Mode To View Compartment Temperature History Only - Begin with the unit ON. Now, press and hold the desired compartment WARMER key, then press the UNIT ON/OFF key, then release both keys (See Figure 3-42). The left display area on the LCD will show average compartment thermistor temperature and in the right display area will be the index number. The first index number will be "1", indicating the most recent two-hour temperature average. The right display area will also flash the thermistor location code at 3 second intervals (See Figure 3-43).

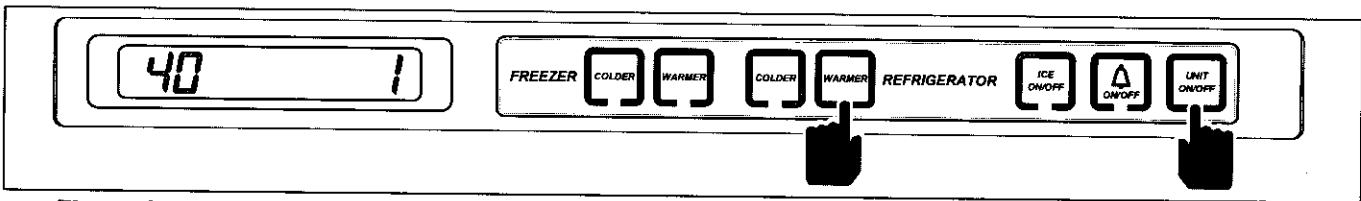

Figure 3-42. Initiate Temperature Log Recall Mode To View Compartment Temperature History Only - Press and Hold Desired WARMER Key, Then Press UNIT ON/OFF Key

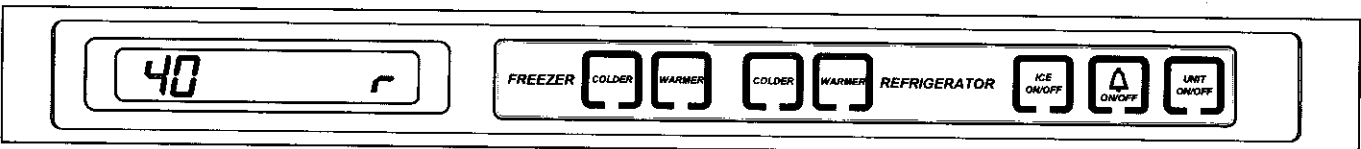

Figure 3-43. Thermistor Location Code Flashes Every 3 Seconds

To toggle up through the indexes (from 1 to 168), press the same WARMER key in multiple key strokes (See Figure 3-44). To toggle down through the indexes (from 168 to 1), press the corresponding COLDER key in multiple key strokes (See Figure 3-45).

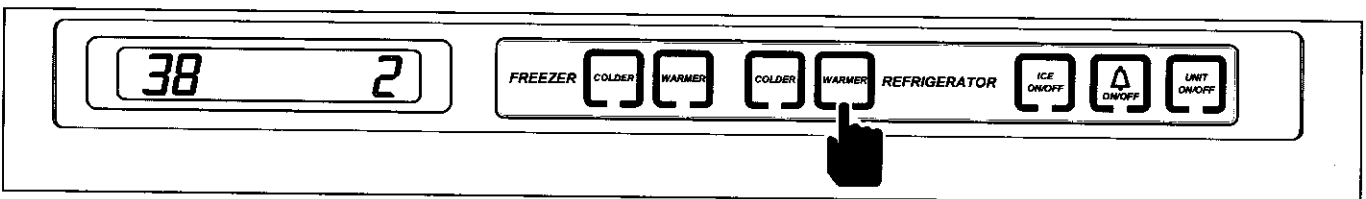

Figure 3-44. Toggle Up Through Indexes - Press WARMER Key in Consecutive Key Strokes

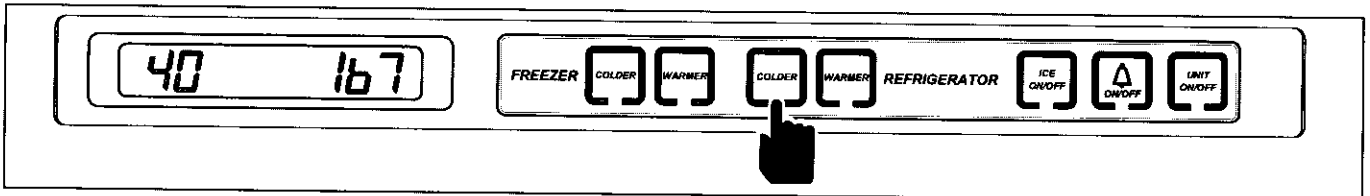

Figure 3-45. Toggle Down Through Indexes - Press COLDER Key in Consecutive Key Strokes

Initiate Temperature Log Recall Mode To View Compartment and Evaporator Temperature History - To view compartment and/or evaporator temperature history, begin with the unit ON and in Diagnostic Mode (See Figure 30-46). While in Diagnostic Mode, toggle through the readings until the desired thermistor temperature is displayed on the LCD (See Figure 3-47). Now, press and hold the UNIT ON/OFF key first, then the WARMER key, then release both keys (See Figure 3-48). The left display area on the LCD will show average thermistor temperature and in the right display area will be the index number "1" indicating the most recent two-hour temperature average. The right display area will also flash the thermistor location code at 3 second intervals (See Figure 3-49).

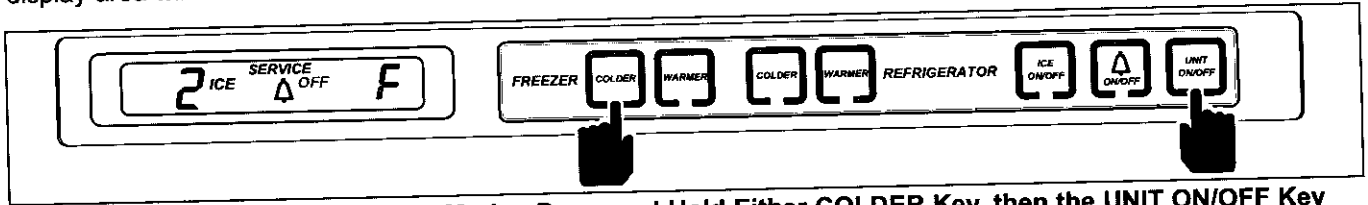

Figure 3-46. Initiate Diagnostic Mode - Press and Hold Either COLDER Key, then the UNIT ON/OFF Key

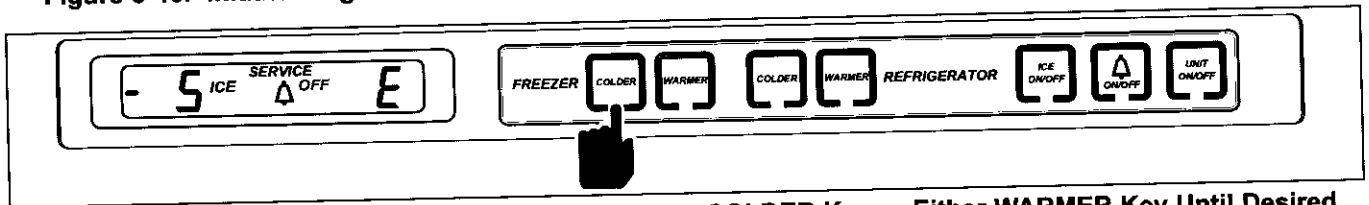

Figure 3-47. Toggle Through Readings - Press Either COLDER Key or Either WARMER Key Until Desired Thermistor Temperature is Displayed

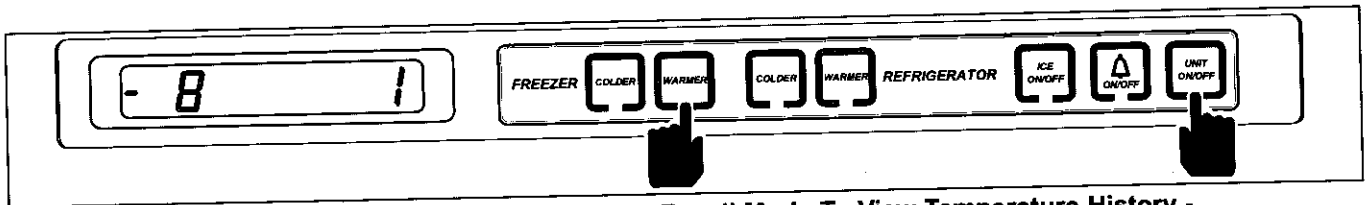

Figure 3-48. Initiate Temperature Log Recall Mode To View Temperature History - Press and Hold UNIT ON/OFF key first, then WARMER Key

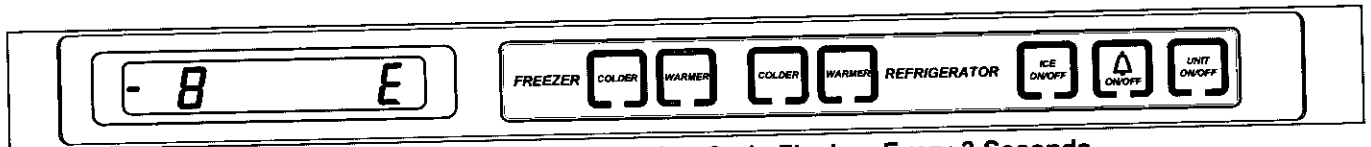

Figure 3-49. Thermistor Location Code Flashes Every 3 Seconds

To toggle up through the indexes (from 1 to 168), press the same WARMER key in multiple key strokes (See Figure 3-50). To toggle down through the indexes (from 168 to 1), press the corresponding COLDER key in multiple key strokes (See Figure 3-51).

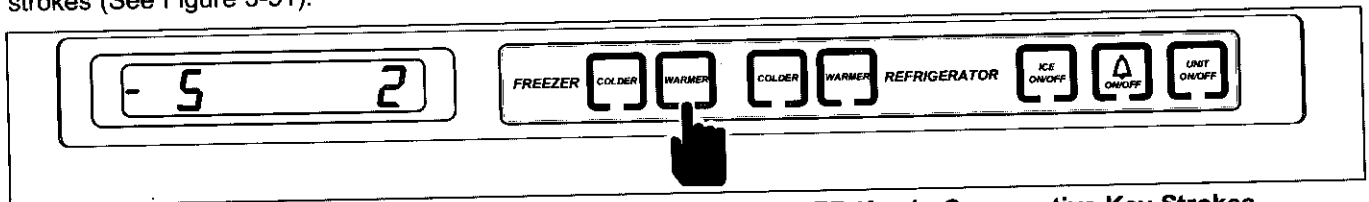

Figure 3-50. Toggle Up Through Indexes - Press WARMER Key in Consecutive Key Strokes

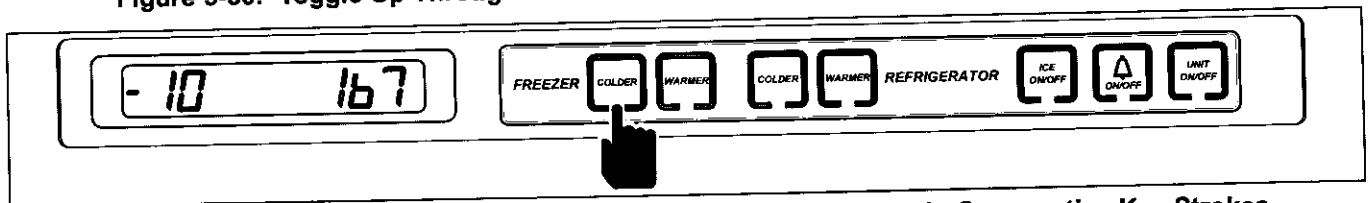

Figure 3-51. Toggle Down Through Indexes - Press COLDER Key in Consecutive Key Strokes

Temperature Log Event Indicators

The diagrams below illustrate possible event indicators that may be observed while in Temperature Log Recall Mode. (See Figures 3-50 through 3-52 and Temperature Log Index Chart on next page))

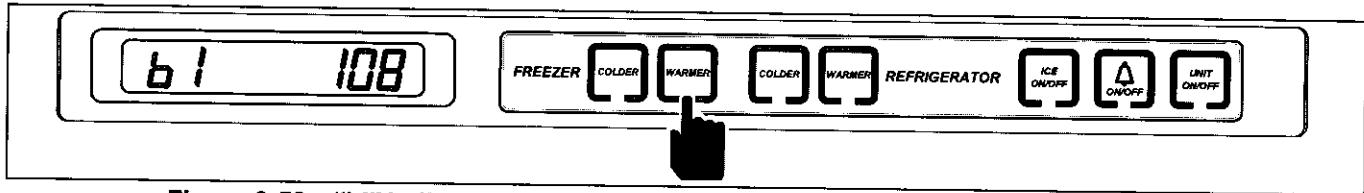

Figure 3-52. "bl" Indicates Index is "blank" - No Temperature has Been Logged Yet
(Only possible within first 14 days of unit operation, or after new control board is installed during service)

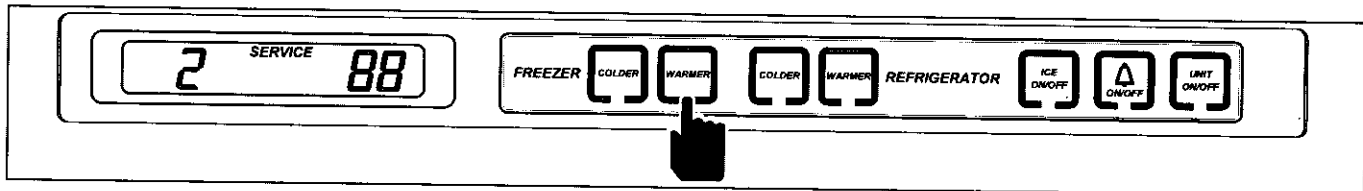

Figure 3-53. SERVICE Illuminates - Indicates Unit was switched OFF During that Index Period by Pressing UNIT ON/OFF Key

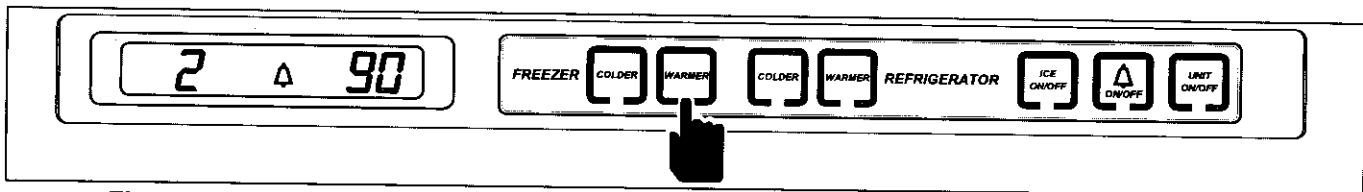

Figure 3-54. Bell Illuminates - Indicates Power Failure / Interruption During that Index Period

NOTE: If the unit was in Showroom Mode during any of the 168 indexes, average temperatures will continue to be logged. No event indicator will appear with these temperatures.

NOTE: If the unit was switched OFF by pressing the UNIT ON/OFF key during any of the 168 indexes and there was still power supplied to the control board, the average temperatures will continue to be logged. This means temperatures would be expected to rise and the SERVICE icon would be present in all indexes in which the unit was OFF.

NOTE: Temperature Log Recall Mode will end 20 seconds after the last key stroke.



Temperature Log Index Chart

NOTE : The chart below applies to the hours in which the control has power. Temperature history data will only be stored when the control has 115V AC supplied to it. If power to the unit is interrupted, the average temperatures for that time period are stored with the event indicator. The temperature history data is stored in a non-volatile memory, so the data is not erased by a power failure, but actual time passage during the power failure will not be shown.

TEMPERATURE LOG INDEX CHART			
Index= Hours Past	Index= Hours Past	Index= Hours Past	Index= Hours Past
1 = 2 Hrs	43 = 86 Hrs	85 = 170 Hrs	127 = 254 Hrs
2 = 4 Hrs	44 = 88 Hrs	86 = 172 Hrs	128 = 256 Hrs
3 = 6 Hrs	45 = 90 Hrs	87 = 174 Hrs	129 = 258 Hrs
4 = 8Hrs	46 = 92 Hrs	88 = 176 Hrs	130 = 260 Hrs
5 = 10Hrs	47 = 94 Hrs	89 = 178 Hrs	131 = 262 Hrs
6 = 12 Hrs	48 = 96 Hrs (4 Days)	90 = 180 Hrs	132 = 264 Hrs (11 Days)
7 = 14 Hrs	49 = 98 Hrs	91 = 182 Hrs	133 = 266 Hrs
8 = 16 Hrs	50 = 100 Hrs	92 = 184 Hrs	134 = 268 Hrs
9 = 18 Hrs	51 = 102 Hrs	93 = 186 Hrs	135 = 270 hrs
10 = 20 Hrs	52 = 104 Hrs	94 = 188 Hrs	136 = 272 Hrs
11 = 22 Hrs	53 = 106 Hrs	95 = 190 Hrs	137 = 274 Hrs
12 = 24 Hrs (1 Day)	54 = 108 Hrs	96 = 192 Hrs (8 Days)	138 = 276 Hrs
13 = 26 Hrs	55 = 110 Hrs	97 = 194 Hrs	139 = 278 Hrs
14 = 28 Hrs	56 = 112 Hrs	98 = 196 Hrs	140 = 280 Hrs
15 = 30 Hrs	57 = 114 Hrs	99 = 198 Hrs	141 = 282 Hrs
16 = 32 Hrs	58 = 116 Hrs	100 = 200 Hrs	142 = 284 Hrs
17 = 34 Hrs	59 = 118 Hrs	101 = 202 Hrs	143 = 286 Hrs
18 = 36 Hrs	60 = 120 Hrs (5 Days)	102 = 204 Hrs	144 = 288 Hrs (12 Days)
19 = 38 Hrs	61 = 122 Hrs	103 = 206 Hrs	145 = 290 Hrs
20 = 40 Hrs	62 = 124 Hrs	104 = 208 Hrs	146 = 292 Hrs
21 = 42 Hrs	63 = 126 Hrs	105 = 210 Hrs	147 = 294 Hrs
22 = 44 Hrs	64 = 128 Hrs	106 = 212 Hrs	148 = 296 Hrs
23 = 46 Hrs	65 = 130 Hrs	107 = 214 Hrs	149 = 298 Hrs
24 = 48 Hrs (2 Days)	66 = 132 Hrs	108 = 216 Hrs (9 Days)	150 = 300 Hrs
25 = 50 Hrs	67 = 134 Hrs	109 = 218 Hrs	151 = 302 Hrs
26 = 52 Hrs	68 = 136 Hrs	110 = 220 Hrs	152 = 304 Hrs
27 = 54 Hrs	69 = 138 Hrs	111 = 222 Hrs	153 = 306 Hrs
28 = 56 Hrs	70 = 140 Hrs	112 = 224 Hrs	154 = 308 Hrs
29 = 58 Hrs	71 = 142 Hrs	113 = 226 Hrs	155 = 310 Hrs
30 = 60 Hrs	72 = 144 Hrs (6 Days)	114 = 228 Hrs	156 = 312 Hrs (13 Days)
31 = 62 Hrs	73 = 146 Hrs	115 = 230 Hrs	157 = 314 Hrs
32 = 64 Hrs	74 = 148 Hrs	116 = 232 Hrs	158 = 316 Hrs
33 = 66 Hrs	75 = 150 Hrs	117 = 234 Hrs	159 = 318 Hrs
34 = 68 Hrs	76 = 152 Hrs	118 = 236 Hrs	160 = 320 Hrs
35 = 70 Hrs	77 = 154 Hrs	119 = 238 hrs	161 = 322 Hrs
36 = 72 Hrs (3 Days)	78 = 156 Hrs	120 = 240 Hrs (10 Days)	162 = 324 Hrs
37 = 74 Hrs	79 = 158 Hrs	121 = 242 Hrs	163 = 326 hrs
38 = 76 Hrs	80 = 160 Hrs	122 = 244 Hrs	164 = 328 Hrs
39 = 78 Hrs	81 = 162 Hrs	123 = 246 Hrs	165 = 330 Hrs
40 = 80 Hrs	82 = 164 Hrs	124 = 248 Hrs	166 = 332 Hrs
41 = 82 Hrs	83 = 166 Hrs	125 = 250 Hrs	167 = 334 Hrs
42 = 84 Hrs	84 = 168 Hrs (7 Days)	126 = 252 Hrs	168 = 336 Hrs (14 Days)



ELECTRONIC CONTROL SERVICE INPUT OPERATIONS

Model Configuration Mode

The main control board is used in several different models, so when a 700-3 Base Unit is manufactured, the main control board must be configured/programmed for the specific model it is used in by a series of key strokes at the control panel. This is called Model Configuration.

If a new main control board is installed during a service call, double dashes (- -) will appear on the LCD (See Figure 3-55). This indicates the new board must be configured for the model it was installed into. This is accomplished in Model Configuration Mode, which is entered as soon as power is supplied to the unit. While in this mode, open the bottom drawer, then toggle through the model codes by pressing WARMER or COLDER keys, until appropriate model code is displayed (See Figure 3-56 and 3-57, and Model Code Table below). With appropriate model code displayed, press UNIT ON/OFF key to store model configuration (See Figure 3-58).

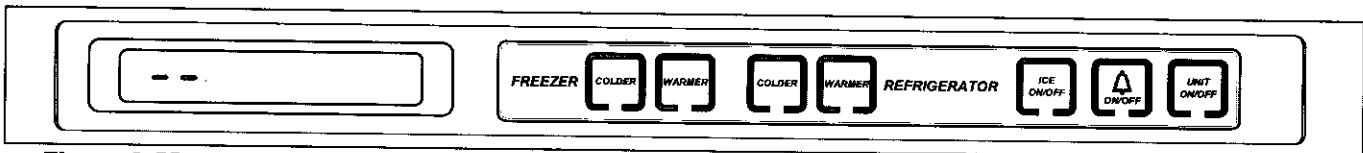

Figure 3-55. " - - " Double Dashes when New Board Installed = Model Configuration must be Performed

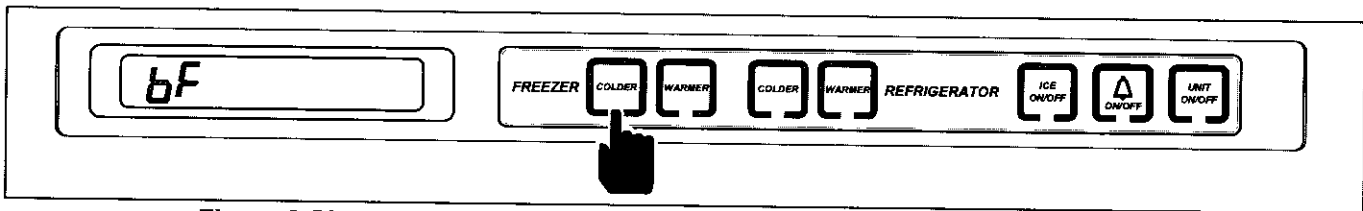

Figure 3-56. Press WARMER or COLDER key to Toggle Through Model Codes

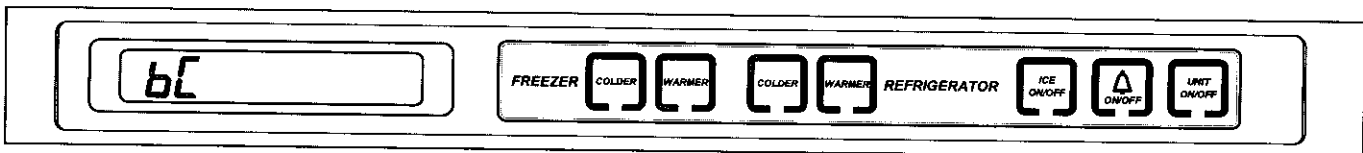

Figure 3-57. Stop When Appropriate Model Code is Displayed

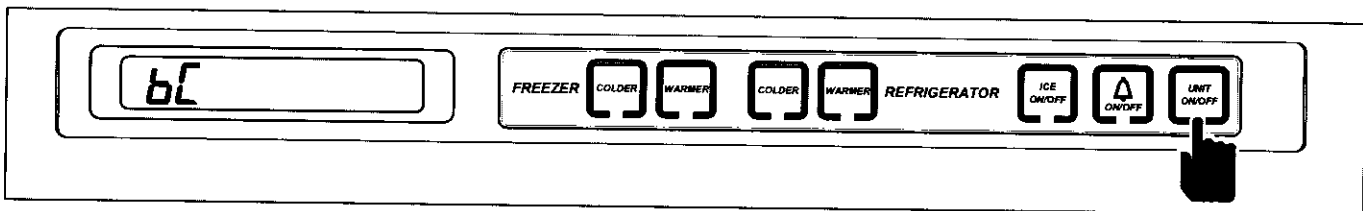

Figure 3-58. Press UNIT ON/OFF Key to Store Model Configuration

MODEL CODE TABLE	
CODE	MODEL
br	700BR-3
bC	700BCI-3
27	427R-2
bF	700BFI-3

Manual Entry Model Configuration Mode

Manual Entry Model Configuration Mode allows a Service Technician to verify a main control board in a 700-3 Base unit was configured correctly, and/or to reconfigure the main control board if a mistake was made during the configuration process.

To initiate Manual Entry Model Configuration Mode the unit must be ON and the bottom drawer open. Then, Press and hold the drawer ajar alarm bell ON/OFF key and the UNIT ON/OFF key together for 15 seconds. The unit will now be in Model Configuration Mode, with the model code of the last configuration displayed (See Figure 3-59 and Model Code Table on previous page). If needed, toggle through the model codes by pressing WARMER or COLDER keys, until appropriate model code is displayed (See Figure 3-60 and 3-61). With appropriate model code displayed, press UNIT ON/OFF key to store model configuration (See Figure 3-62).

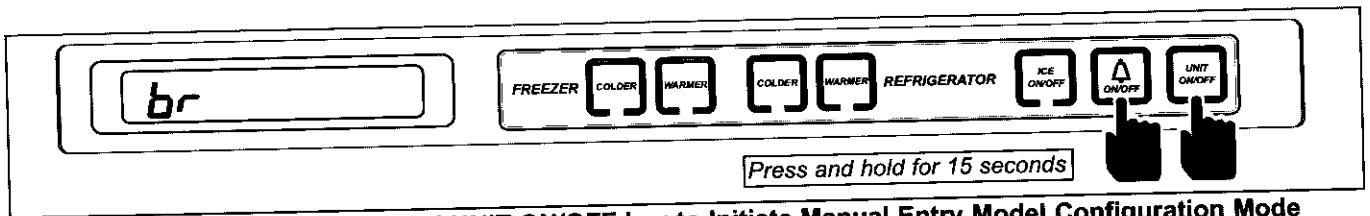

Figure 3-59. Press Alarm and UNIT ON/OFF key to Initiate Manual Entry Model Configuration Mode

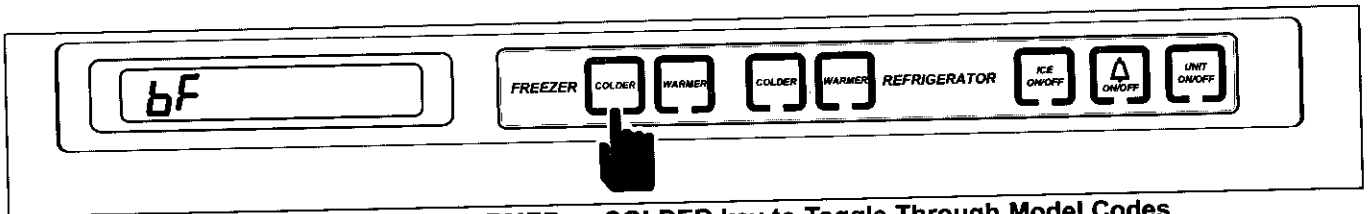

Figure 3-60. Press WARMER or COLDER key to Toggle Through Model Codes

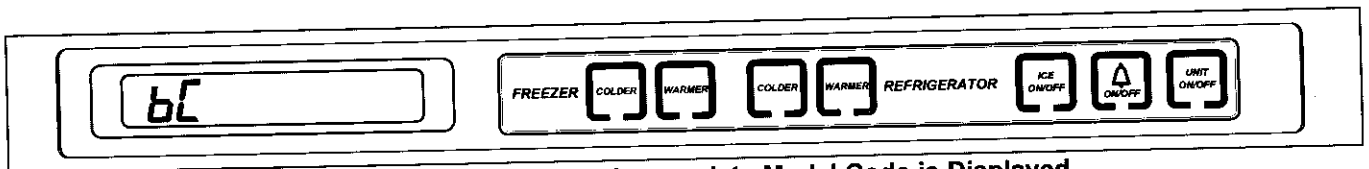

Figure 3-61. Stop When Appropriate Model Code is Displayed

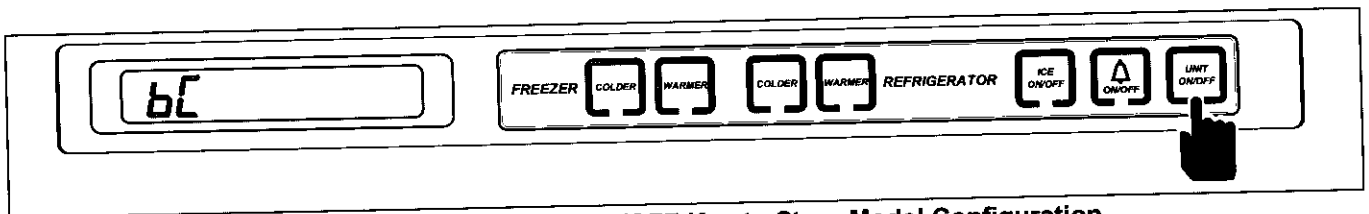

Figure 3-62. Press UNIT ON/OFF Key to Store Model Configuration